

SSG5000X Series Signal Generator

Programming Guide

PG0805X-E01B

1.	Programming Overview	5
1.1	Build Communication	5
1.1.1	Build Communication Using VISA	5
1.1.2	Build Communication Using Sockets	8
1.1.3	Connecting the signal generator via the USB Host port	9
1.2	Remote Control Capabilities	9
1.2.1	User-defined Programming	9
1.2.2	Send SCPI Commands via NI-MAX	9
2.	SCPI Overview	14
2.1	Command Format	14
2.2	Symbol Instruction	14
2.3	Parameter Type	15
2.4	Command Abbreviation	16
3.	SCPI Commands	18
3.1	IEEE Common Commands	18
3.1.1	Identification Query (*IDN)	18
3.1.2	Reset (*RST)	18
3.1.3	Clear Status (*CLS)	19
3.1.4	Standard Event Status Enable (*ESE)	19
3.1.5	Standard Event Status Register Query (*ESR)	19
3.1.6	Operation Complete Query (*OPC)	19
3.1.7	Service Request Enable (*SRE)	20
3.1.8	Status Byte Query (*STB)	20
3.1.9	Wait-to-Continue (*WAI)	20
3.1.10	Self Test Query (*TST)	21
3.2	System Subsystem	21
3.2.1	System Time (:SYSTEM:TIME)	21
3.2.2	System Date (:SYSTEM:DATE)	21
3.2.3	IP Address (:SYSTEM:COMMunicate:LAN:IPADdress)	22
3.2.4	Gateway (:SYSTEM:COMMunicate:LAN:GATeway)	22
3.2.5	Subnet Mask (:SYSTEM:COMMunicate:LAN:SMASk)	23

3.2.6	IP Config (:SYSTem:COMMunicate:LAN:TYPE)	23
3.2.7	Power On Type (:SYSTem:PON:TYPE).....	24
3.2.8	10M Adjustment State (:SYSTem:REF:DAC:STAT)	24
3.2.9	Ref Osc Code (:SYSTem:REF:DAC)	25
3.2.10	Ref Osc Code Store (:SYSTem:REF:DAC:SAVE)	25
3.2.11	Ref Osc Code Load (:SYSTem:REF:DAC:LOAD)	25
3.2.12	Reset Ref Osc Code to Default (:SYSTem:REF:DAC:DEFault)	26
3.3	Preset Subsystem	26
3.3.1	Preset (:SOURce:PRESet)	26
3.3.1	System Preset (:SYSTem:PRESet).....	27
3.3.2	Preset Save (:SYSTem:PRESet:SAVE).....	27
3.3.3	Preset Path (:SYSTem:PRESet:PATH).....	27
3.3.4	Preset Type (:SYSTem:PRESet:TYPE)	28
3.3.5	Factory Reset (:SYSTem:FDEFault)	28
3.4	Output Subsystem.....	28
3.4.1	RF Output (:OUTPut[:STATe]).....	28
3.5	Source Subsystem	29
3.5.1	[:SOURce]:FREQuency Subsystem	29
3.5.2	[:SOURce]:POWEr Subsystem	31
3.5.3	[:SOURce]:SWEep Subsystem.....	41
3.5.4	[:SOURce]:MODulation Subsystem.....	51
3.5.5	[:SOURce]:AM Subsystem	52
3.5.6	[:SOURce]:FM Subsystem.....	54
3.5.7	[:SOURce]:PM Subsystem	57
3.5.8	[:SOURce]:PULM Subsystem	59
3.5.9	[:SOURce]:LFOutput Subsystem.....	71
3.5.10	[:SOURce]:LFOutput:SWEep Subsystem	73
3.6	Sense Subsystem	78
3.6.1	Sensor Info (:SENSe[:POWEr]:TYPE).....	78
3.6.2	Sensor State (:SENSe[:POWEr]:STATus).....	78
3.6.3	Measurement (:SENSe[:POWEr]:VALue).....	78
3.6.4	Statistics State (:SENSe[:POWEr]:STATISTics:STATe)	79
3.6.5	Statistics Value (:READ[:POWEr])	79
3.6.6	Statistics Max Value (:SENSe[:POWEr]:STATISTics:MAX?)	80
3.6.7	Statistics Min Value (:SENSe[:POWEr]:STATISTics:MIN?)	80
3.6.8	Statistics Mean Value (:SENSe[:POWEr]:STATISTics:AVG?)	81

3.6.9	Statistics Count (:SENSe[:POWer]:STATIStics:COUNT?).....	81
3.6.10	Statistics Clear (:SENSe[:POWer]:STATIStics:CLEAR).....	81
3.6.11	Auto Zero (:CALibration:ZERO:TYPE)	82
3.6.12	Zeroing (:SENSe[:POWer]:ZERO).....	82
3.6.13	Frequency Type (:SENSe[:POWer]:SOURce)	83
3.6.14	Frequency (:SENSe[:POWer]:FREQuency)	83
3.6.15	Level Offset State (:SENSe[:POWer]:OFFSet:STATe).....	83
3.6.16	Level Offset (:SENSe[:POWer]:OFFSet).....	84
3.6.17	Average Type (:SENSe[:POWer]:FILTer:TYPE)	84
3.6.18	Average Times (:SENSe[:POWer]:FILTer:LENGth).....	85
3.6.19	Internal Noise (:SENSe[:POWer]:FILTer:NSRatio)	85
3.6.20	Logging (:SENSe[:POWer]:LOGGing:STATe)	85
3.7	I/Q Subsystem.....	86
3.7.1	[:SOURce]:FUNCTion Subsystem	86
3.7.2	[:SOURce]:RADio:CUSTom Subsystem	86
3.7.3	[:SOURce]:RADio:MTONe Subsystem.....	96
3.7.4	[:SOURce]:RADio:DMODulation Subsystem.....	99
3.7.5	[:SOURce]:RADio:ARB Subsystem	101
3.7.6	[:SOURce]:RADio:AWGN Subsystem	121
3.7.7	[:SOURce]:DM Subsystem	122
3.7.8	[:SOURce]:IQ:DUALarb Subsystem	128
3.7.9	:MEMory Subsystem.....	132
4.	Programming Examples	134
4.1	VISA Examples	134
4.1.1	VC++ Example	134
4.1.2	VB Example	140
4.1.3	MATLAB Example.....	144
4.1.4	LabVIEW Example.....	147
4.2	Socket Examples	149
4.2.1	Python Example	149
4.2.2	Telnet Example	151

1. Programming Overview

The **SSG5000X** supports both USB and LAN interfaces. By using these interfaces, in combination with NI-VISA and programming languages, users can remotely control the signal generator. The instrument comes with an embedded web interface; VXI-11, Sockets and Telnet protocols can be used to communicate with the signal generator. This chapter introduces how to build communication between the signal generator and the PC. It also introduces the remote control capabilities.

1.1 Build Communication

1.1.1 Build Communication Using VISA

1. Install NI-VISA

Before programming, you will need to install NI-VISA, which you can download from the National Instruments VISA web site. There are full and Run-Time Engine versions of NI-VISA. The full version includes the NI device driver and a tool named NI MAX which is a user interface to control the device. The Run-Time Engine version is a smaller file than the full version only includes the NI device driver.

For example, you can get NI-VISA 18.0 full version from: <http://www.ni.com/download/ni-visa-18.0/7597/en/>.

You can also download NI-VISA Run-Time Engine 18.0 to your PC and install it as default selection. Its installation process is similar with the full version.

After you downloaded the file you can follow the steps below to install it:

a. Double click the NIVISA1800full.exe, dialog shown as below:

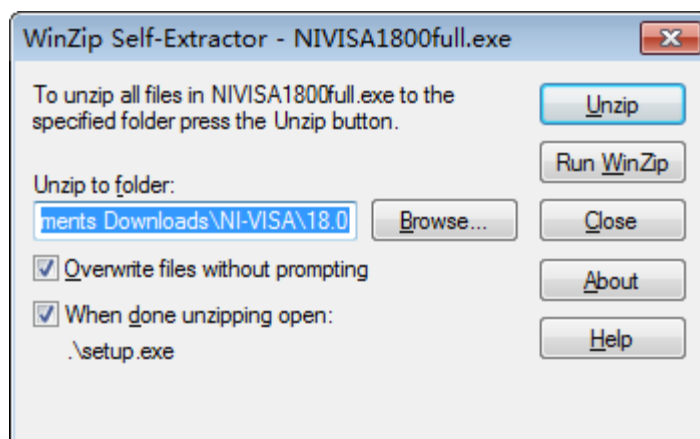

b. Click Unzip, the installation process will automatically launch after unzipping files. If your computer needs to install .NET Framework 4.6.2, its setup process will auto start.



c. The NI-VISA installing dialog is shown above. Click Next to start the installation process.

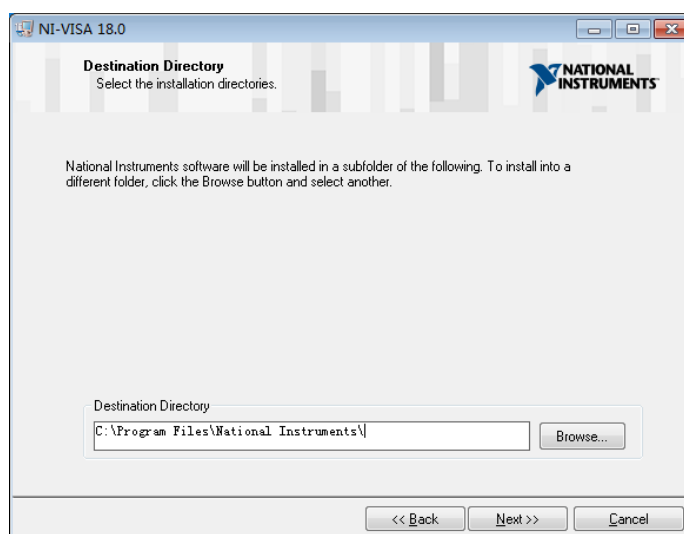

Set the install path, default path is “C:\Program Files\National Instruments\”, you can change it. Click Next, dialog shown as above.

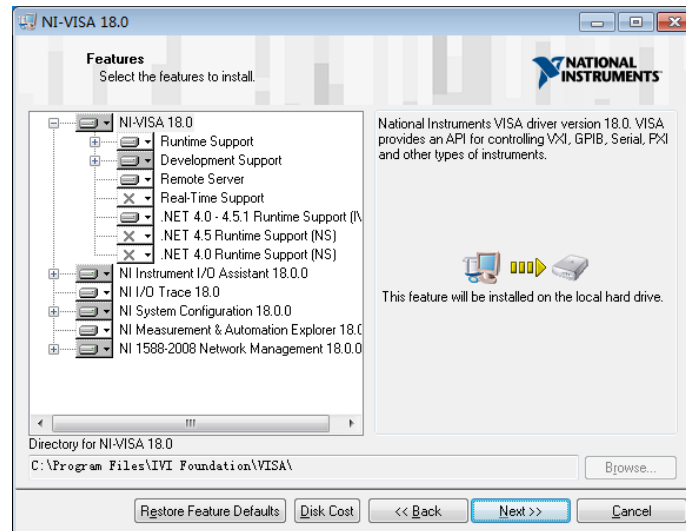

d. Click Next twice, in the License Agreement dialog, select the “I accept the above 2 License Agreement(s).”, and click Next, “Start Installation” dialog shown.

e. Click Next to run installation.

f.

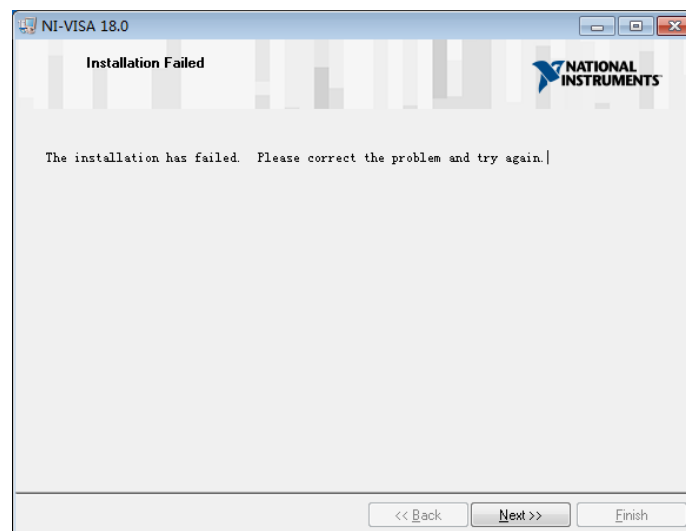

Now the installation is complete, reboot your PC.

2. Connect the Instrument

Depending on your specific model, your signal generator may be able to communicate with a

PC through the USB or LAN interface. This manual uses the USB connection in the examples. (For instructions to communicate with a PC through the LAN interface see the User Manual.)

a. Connect the USB Device interface at the rear panel of the signal generator and the USB Host interface of the PC using a USB cable. Assuming your PC is already turned on, turn on your signal generator and your PC will display the “Device Setup” screen as it automatically installs the device driver as shown below.

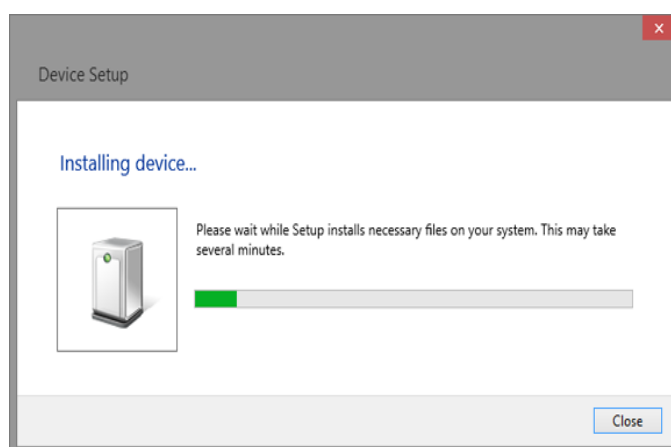

b. Wait for the installation to complete and then proceed to the next step.

1.1.2 Build Communication Using Sockets

LAN communication using Sockets uses the Transmission Control Protocol/Internet Protocol (TCP/IP) layer that is included with many operating systems. A socket is a fundamental technology used for computer networking and allows applications to communicate using standard mechanisms built into network hardware and operating systems. The method accesses a port on the signal generator from which bidirectional communication with a network computer can be established. Unlike VISA, this technique uses currently available resources and doesn't require additional software/hardware to run.

Before you can use sockets, you must select the signal generator socket port number to use:

- Standard mode. Available on port 5025. Use this port for simple programming.
- Telnet mode. The telnet SCPI service is available on port 5024.

1.1.3 Connecting the signal generator via the USB Host port

Refer to the following steps to finish the connection via USB:

1. Install NI-VISA on your PC for GPIB driver.
2. Connect the signal generator USB Host port to a PC's GPIB card port, with SIGLENT USB-GPIB adaptor.



3. Switch on the signal generator.
4. Press button on the front panel **System** → Interface → GPIB to enter the GPIB number.

The signal generator will be detected automatically as a new GPIB point.

1.2 Remote Control Capabilities

1.2.1 User-defined Programming

Users can use SCPI commands to program and control the signal generator. For details, refer to the introductions in “Programming Examples”.

1.2.2 Send SCPI Commands via NI-MAX

Users can control the signal generator remotely by sending SCPI commands via NI-MAX software.

1.2.2.1 Using USB

Run NI MAX software.

1. Click “Device and interface” at the upper left corner of the software.
2. Find the “USBTMC” device symbol.

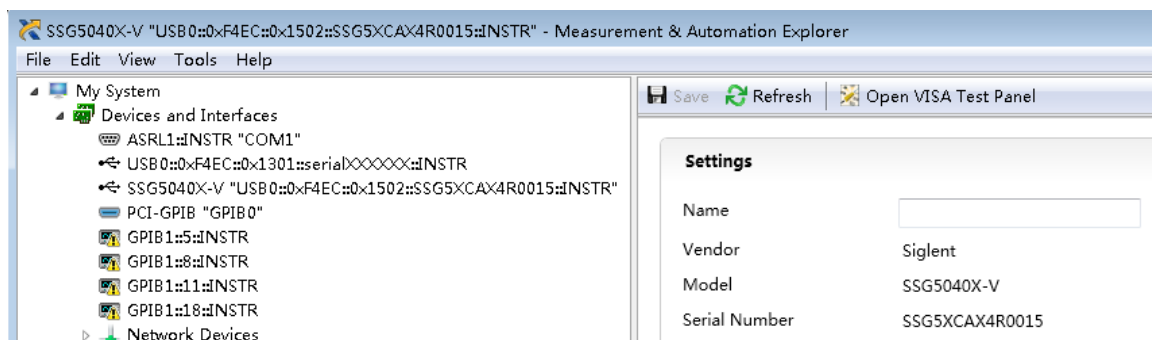

3. Click “Open VISA Test Panel” option button, then the following interface will appear.

4. Click the “Input/Output” option button and click the “Query” option button in order to view the operation information.

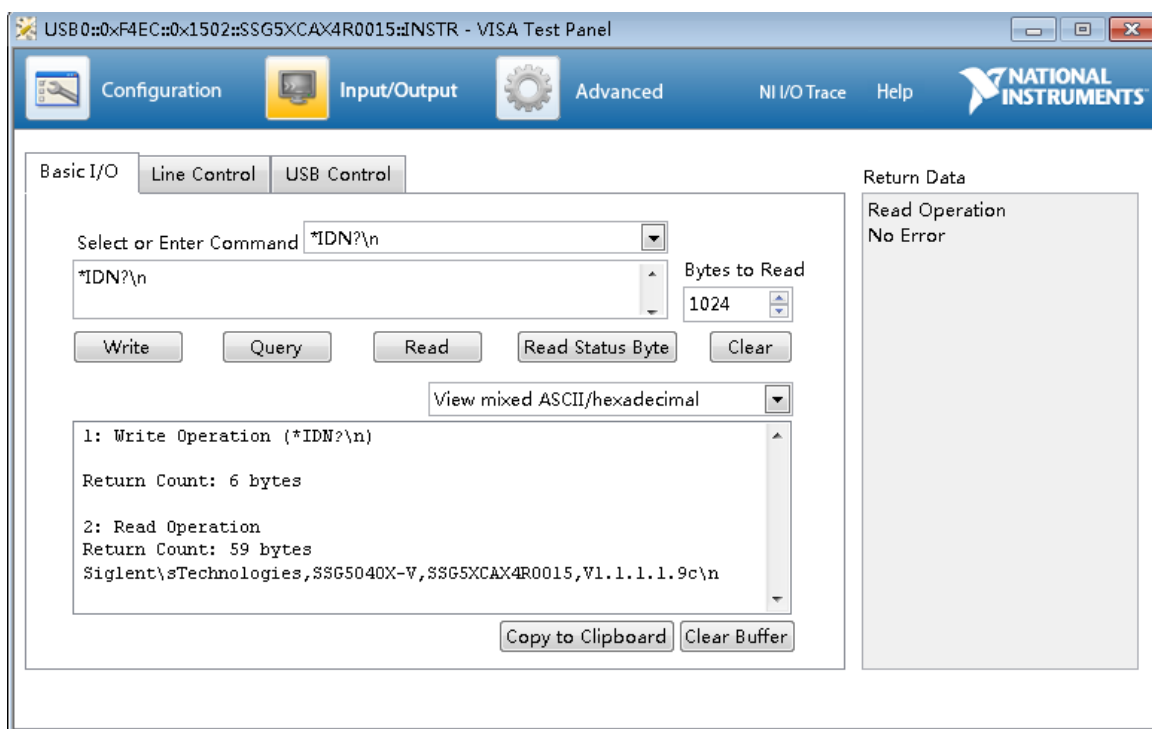

NOTE: The “*IDN?” command (known as the Identification Query) returns the instrument manufacturer, instrument model, serial number, and other identification information.

1.2.2.2 Using LAN

Add a Network Device, and select a VISA TCP/IP Resource as shown:

Run NI MAX software.

1. Click “Device and interface” at the upper left corner of the software
2. Find the “Network Devices” symbol, click “Add Network Devices”

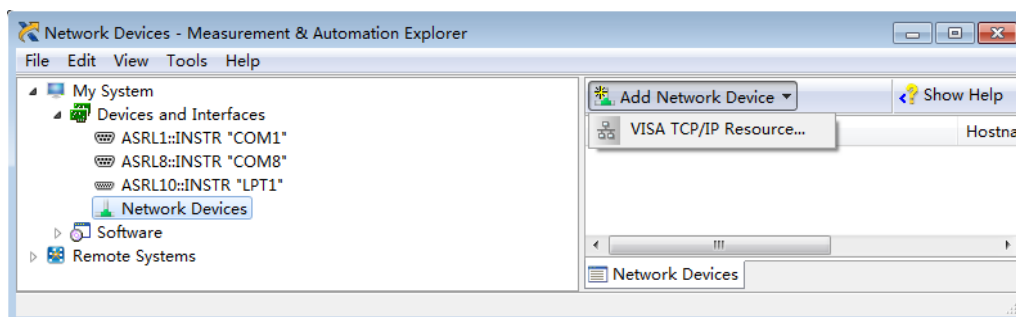

3. Select Manual Entry of LAN instrument, select Next, and enter the IP address as shown.

Click Finish to establish the connection:

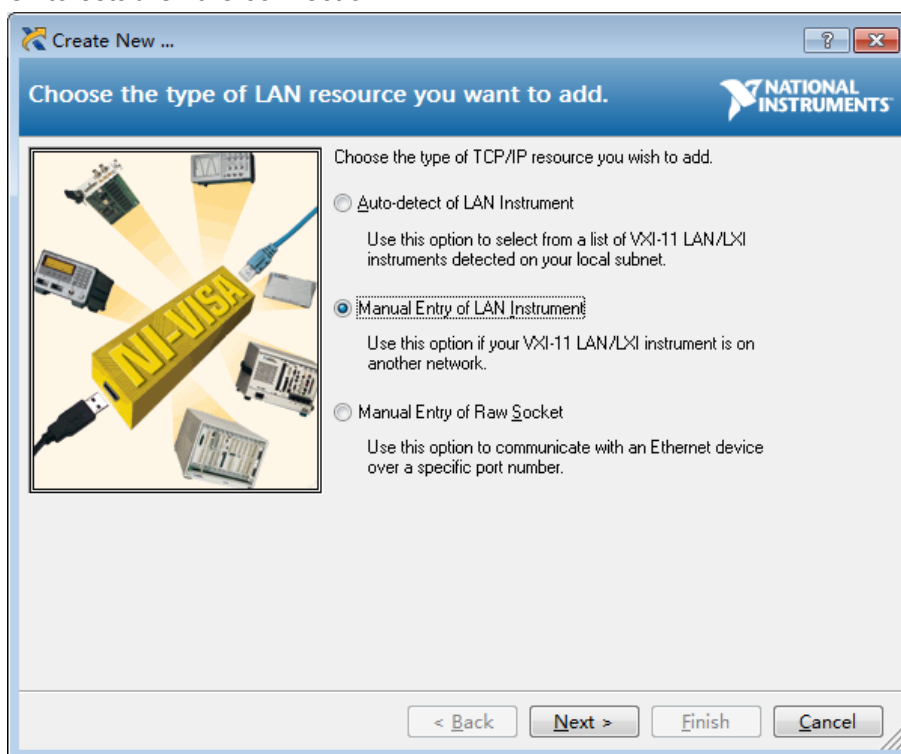

NOTE: Leave the LAN Device Name BLANK or the connection will fail.

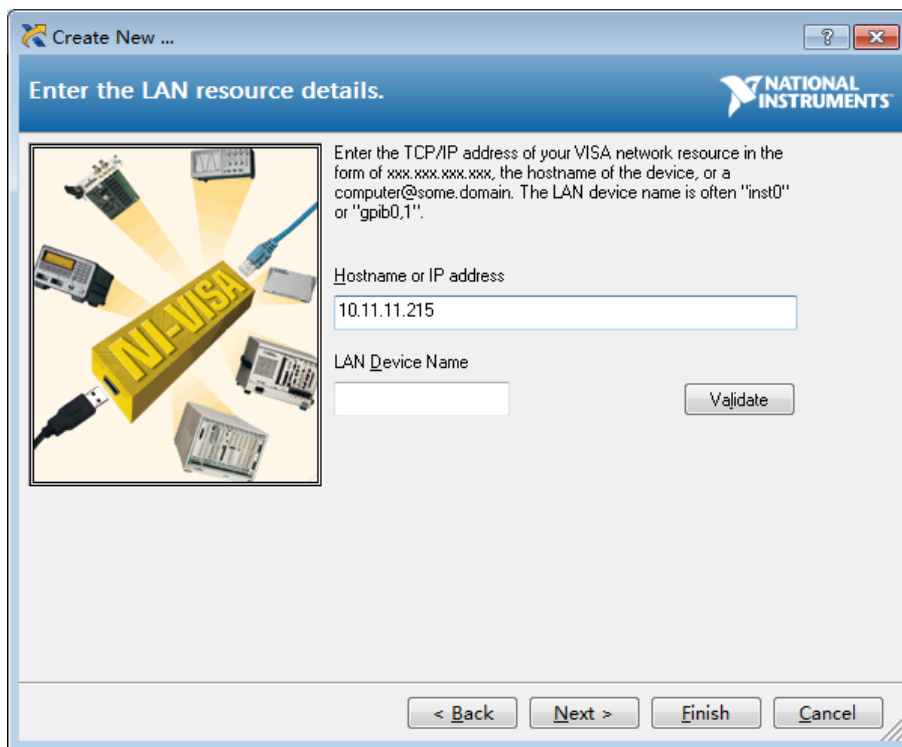

4. After a brief scan, the connection should be shown under Network Devices:

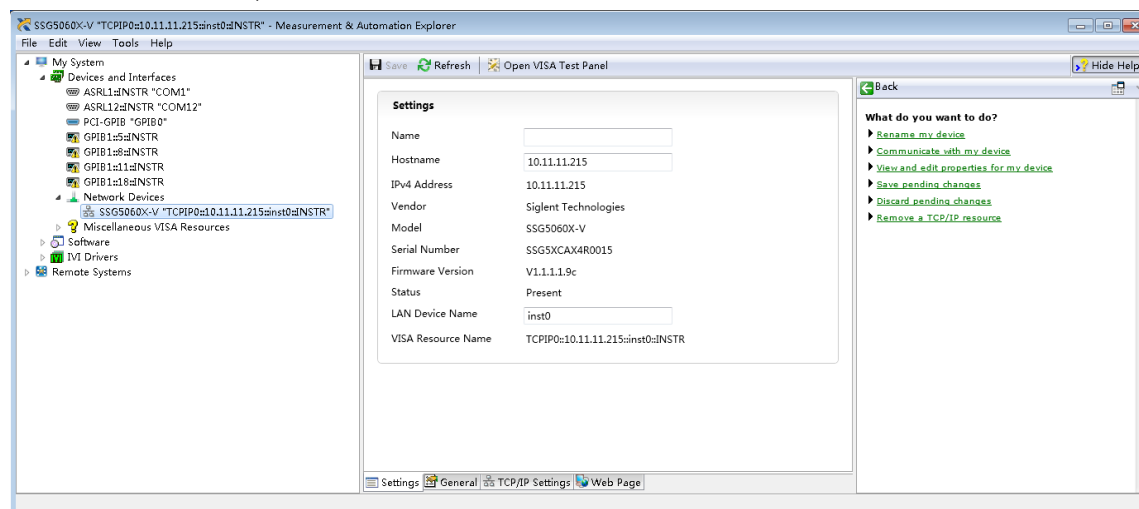

5. Right-click on the product and select Open NI-VISA Test Panel:

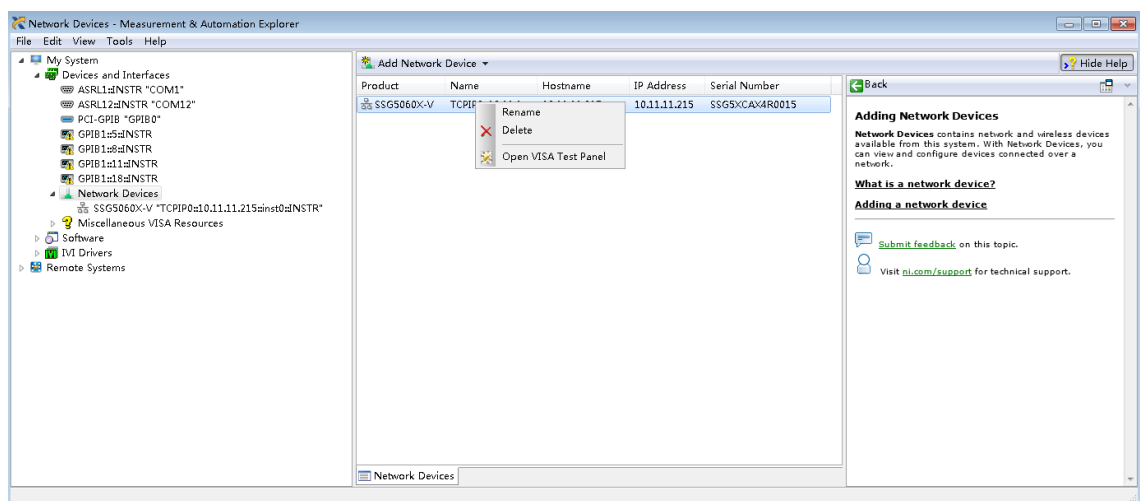

6. Click “Input/Output” option button and click “Query” option button. If everything is OK, you will see the Read operation information returned as shown below.

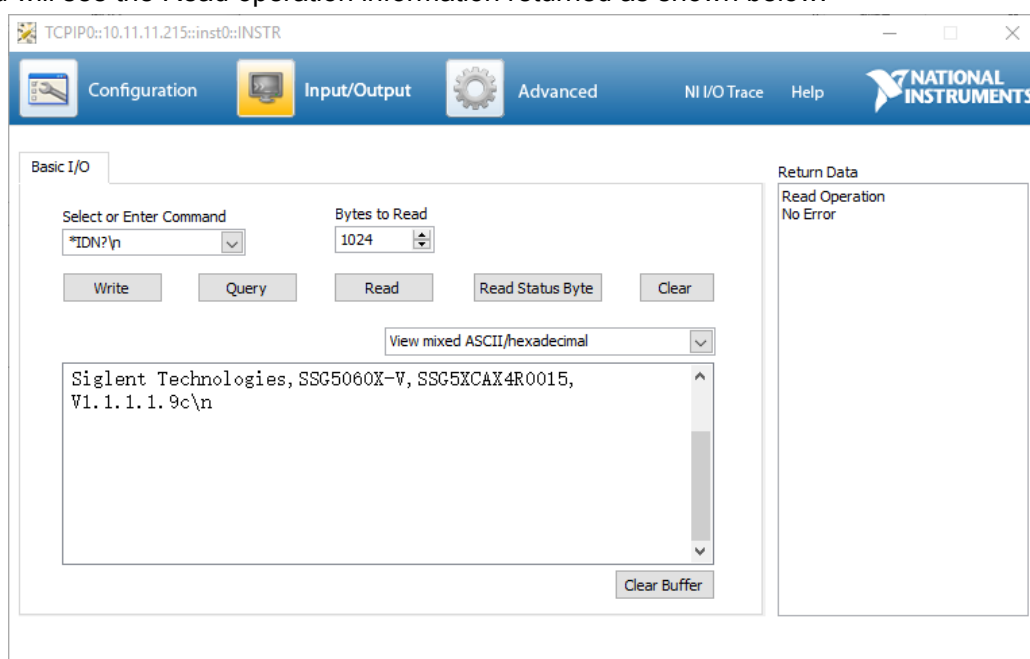

2. SCPI Overview

2.1 Command Format

SCPI commands present a hierarchical tree structure containing multiple subsystems; each of the subsystems is made up of a root keyword and several sub keywords. The command string usually starts with a colon “:”, the keywords are separated by a colon “:” and the parameter settings are separated by spaces. Query commands add a question mark “?” to the end of the string.

For example:

```
:SOURce:FREQuency <freq>
```

```
:SOURce:FREQuency?
```

SOURce is the root key of the command, FREQuency is second.

The command begins with “:”, and separates the keywords at the same time, <freq> separated by space and represents the parameter available for setting; “?” represents a query. A query sent to the instrument indicates that the instrument will have a response string. Therefore, queries ask a question and expect a response.

2.2 Symbol Instruction

The following four symbols are not the content of SCPI commands and cannot be sent with the commands, but are used to describe certain aspects of the commands.

1. Triangle Brackets < >

The parameter in the triangle brackets must be replaced by an effective value. For example: Send the “CALibration:SPC:TARGet <power>” command in “CALibration:SPC:TARGet 0”.

2. Square Brackets []

The content in the square brackets can be ignored. When the parameter is ignored, the instrument will set the parameter to its default.

For example,

In the “[:SOURce]:POWer?” command, sending either of the commands below can generate the same effect:

```
:SOURce:POWer?
```

```
:POWer?
```

3. Vertical Bar |

The vertical bar is used to separate multiple parameters and when sending the command, you can choose one of the parameters.

For example,

In the “[:SOURce]:AM:STATe OFF|ON|0|1” command, the parameters available are “OFF”, “ON”, “0” or “1”.

4. Braces { }

The parameters in the braces are optional which can be ignored or set for one or more times.

2.3 Parameter Type

The parameters in the commands introduced in this manual include 6 types: Boolean, enumeration, integer, float and string.

1. Boolean

The parameter in the command could be “OFF”, “ON”, “0” or “1”.

For example:

```
[:SOURce]:FM:STATe OFF|ON|0|1
```

2. Enumeration

The parameter could be any of the values listed.

For example:

```
[:SOURce]:SWEep:STATe OFF|FREQuency|LEVel|LEV_FREQ
```

SIGLENT

Valid parameters are “OFF”, “FREQuency”, “LEVel” or LEV_FREQ.

3. Integer

Except other notes, the parameter can be any integer within the effective value range.

For example:

```
[:SOURce]:SWEep:STEP:POINts <value>
```

The parameter <value> can be set to any integer between 2 and 65535.

4. Float

The parameter can be any value within the effective value range according to the accuracy requirement (the default accuracy contains up to 9 digits after the decimal points).

For example:

```
[:SOURce]:POWer:OFFSet <value>
```

The parameter <value> can be set to any real number between -100 and 100.

5. String

The parameter should be the combinations of ASCII characters.

For example:

```
:SYSTem:COMMunicate:LAN:IPADdress <“xxx.xxx.xxx.xxx”>
```

The IP address can be set as the string “192.168.1.12”.

2.4 Command Abbreviation

All of the commands are not case sensitive, so you can use any of them. But if an abbreviation is used, all the capital letters in the command must be written completely.

For example:

:CORRection:FLATness:COUNt?

Can be abbreviated to:

:CORR:FLAT:COUN?

3. SCPI Commands

This chapter introduces the Siglent Technologies SSG5000X SCPI commands, including:

IEEE Common Commands	3.1
System Subsystem	3.2
Preset Subsystem	3.3
Output Subsystem	3.4
Source Subsystem	3.5
Sense Subsystem	3.6
I/Q Subsystem	3.7

3.1 IEEE Common Commands

3.1.1 Identification Query (*IDN)

Command Format	*IDN?
Instruction	Returns an instrument identification information string. The string contains the manufacturer, model number, serial number, software number, FPGA number and CPLD number.
Menu	None
Example	*IDN? Return: Siglent Technologies,SSG5060X,1234567890, 03.01.16r2

3.1.2 Reset (*RST)

Command Format	*RST
Instruction	This command presets the instrument to a factory defined condition that is appropriate for remote programming operation. *RST is equivalent to performing the two commands :SOURce:PRESet and *CLS. This command always performs a factory preset.
Menu	None

Example	*RST
---------	------

3.1.3 Clear Status (*CLS)

Command Format	*CLS
Instruction	Clears the status byte register. It does this by emptying the error queue and clearing all bits in all of the event registers. The status byte register summarizes the states of the other registers. It is also responsible for generating service requests.
Menu	None
Example	*CLS

3.1.4 Standard Event Status Enable (*ESE)

Command Format	*ESE <number> *ESE?
Instruction	Set the bits in the standard event status enable register. This register monitors I/O errors and synchronization conditions such as operation complete, request control, query error, device dependent error, execution error, command error and power on. A summary bit is generated on execution of the command. The query returns the state of the standard event status enable register.
Menu	None
Example	*ESE 16

3.1.5 Standard Event Status Register Query (*ESR)

Command Format	*ESR?
Instruction	Queries and clears the standard event status event register. (This is a destructive read.) The value returned reflects the current state (0/1) of all the bits in the register.
Menu	None
Example	*ESR?

3.1.6 Operation Complete Query (*OPC)

Command	*OPC
---------	------

SIGLENT

Format	*OPC?
Instruction	<p>Set bit 0 in the standard event status register to “1” when all pending operations have finished.</p> <p>The query stops any new commands from being processed until the current processing is complete. Then it returns a “1”, and the program continues. This query can be used to synchronize events of other instruments on the external bus.</p> <p>Returns a “1” if the last processing is complete. Use this query when there’s a need to monitor the command execution status, such as a sweep execution.</p>
Menu	None
Example	*OPC?

3.1.7 Service Request Enable (*SRE)

Command	*SRE <integer>
Format	*SRE?
Instruction	<p>This command enables the desired bits of the service request enable register.</p> <p>The query returns the value of the register, indicating which bits are currently enabled.</p>
Menu	None
Example	*SRE 1

3.1.8 Status Byte Query (*STB)

Command	*STB
Format	*STB
Instruction	This query is used by some instruments for a self test.
Menu	None
Example	*STB

3.1.9 Wait-to-Continue (*WAI)

Command	*WAI
Format	*WAI
Instruction	<p>This command causes the instrument to wait until all pending commands are completed before executing any additional commands.</p> <p>There is no query form to the command.</p>
Menu	None

Example	*WAI
---------	------

3.1.10 Self Test Query (*TST)

Command Format	*TST?
Instruction	This query is used by some instruments for a self test.
Menu	None
Example	*TST?

3.2 System Subsystem

3.2.1 System Time (:SYSTem:TIME)

Command	:SYSTem:TIME <hhmmss>
Format	:SYSTem:TIME?
Instruction	Set the System time Get the System time
Parameter Type	String
Parameter Range	Hours(0 ~ 23), minutes(0 ~ 59), seconds(0 ~ 59)
Return	String
Default	None
Menu	Utility > Setting > Time Setting
Example	Set System time: :SYSTem:TIME 182559 Get System time: :SYSTem:TIME?

3.2.2 System Date (:SYSTem:DATE)

Command	:SYSTem:DATE <yyyymmdd>
Format	:SYSTem:DATE?
Instruction	Set system date Get system date
Parameter	String

SIGLENT

Type	
Parameter Range	Years(four digits), month(1 ~ 12), date(1 ~ 31)
Return	String
Default	None
Menu	Utility > Setting > Time Setting
Example	Set System date: :SYSTem:DATE 20050101 Get System date: :SYSTem:DATE?

3.2.3 IP Address

(:SYSTem:COMMunicate:LAN:IPADdress)

Command	:SYSTem:COMMunicate:LAN:IPADdress <"xxx.xxx.xxx.xxx">
Format	:SYSTem:COMMunicate:LAN:IPADdress?
Instruction	Set the IP address Get the IP address
Parameter Type	String
Parameter Range	Conforms to the IP address standard(0-255:0-255:0-255:0-255)
Return	IP address string
Default	None
Menu	Utility > Interface > LAN Setting > IP Address
Example	:SYSTem:COMMunicate:LAN:IPADdress "192.168.1.12" :SYSTem:COMMunicate:LAN:IPADdress?

3.2.4 Gateway (:SYSTem:COMMunicate:LAN:GATeway)

Command	:SYSTem:COMMunicate:LAN:GATeway <"xxx.xxx.xxx.xxx">
Format	:SYSTem:COMMunicate:LAN:GATeway?
Instruction	Set the gateway for the signal generator in the network. The gateway will be fetched automatically if the IP assignment is set to DHCP. Get the gateway.
Parameter Type	String

Parameter Range	Conforms to the IP standard (0~255.0~255.0~255.0~255)
Return	Gateway string
Default	None
Menu	Utility > Interface > LAN Setting > Gateway
Example	:SYSTem:COMMunicate:LAN:GATeway "192.168.1.1" :SYSTem:COMMunicate:LAN:GATeway?

3.2.5 Subnet Mask

(:SYSTem:COMMunicate:LAN:SMASK)

Command	:SYSTem:COMMunicate:LAN:SMASK <"xxx.xxx.xxx.xxx">
Format	:SYSTem:COMMunicate:LAN:SMASK?
Instruction	Set the subnet mask according to the network settings. The subnet mask will be set automatically if the IP assignment is set to DHCP.
Parameter Type	String
Parameter Range	Conforms to the IP standard (0-255:0-255:0-255:0-255)
Return	Subnet mask string
Default	None
Menu	Utility > Interface > LAN Setting > Subnet Mask
Example	:SYSTem:COMMunicate:LAN:SMASK?

3.2.6 IP Config (:SYSTem:COMMunicate:LAN:TYPE)

Command	:SYSTem:COMMunicate:LAN:TYPE STATIC DHCP
Format	:SYSTem:COMMunicate:LAN:TYPE?
Instruction	Toggles the IP assignment setting between static (manual) and DHCP (dynamic assignment) mode. Get the IP config.
Parameter Type	Enumeration
Parameter Range	STATIC DHCP
Return	Enumeration
Default	None

SIGLENT

Menu	Utility > Interface > LAN Setting > DHCP State
Example	:SYSTem:COMMunicate:LAN:TYPE DHCP :SYSTem:COMMunicate:LAN:TYPE?

3.2.7 Power On Type (:SYSTem:PON:TYPE)

Command	:SYSTem:PON:TYPE DFT LAST
Format	:SYSTem:PON:TYPE?
Instruction	Sets the signal generator power on state. Default is the factory configuration and last recalls all of the settings used before the last power down. Get power on type.
Parameter Type	Enumeration
Parameter Range	DFT LAST DFT: Default LAST: Last
Return	Enumeration
Default	DFT
Menu	Utility > Setting > Power On
Example	SYSTem:PON:TYPE DFT

3.2.8 10M Adjustment State (:SYSTem:REF:DAC:STAT)

Command	:SYSTem:REF:DAC:STAT ON OFF 1 0
Format	:SYSTem:REF:DAC:STAT?
Instruction	Set 10M Adjustment State. Get 10M Adjustment State.
Parameter Type	Boolean
Parameter Range	ON OFF 1 0
Return	Boolean
Default	0
Menu	Utility > Setting > 10M Adjustment
Example	:SYSTem:REF:DAC:STAT ON

3.2.9 Ref Osc Code (:SYSTem:REF:DAC)

Command	:SYSTem:REF:DAC <value>
Format	:SYSTem:REF:DAC?
Instruction	Set ref osc code. Get ref osc code.
Parameter Type	Int
Parameter Range	0 ~ 65535
Return	Int
Default	42885
Menu	Utility > Setting > 10M Adjustment
Example	:SYSTem:REF:DAC 43000 :SYSTem:REF:DAC?

3.2.10 Ref Osc Code Store (:SYSTem:REF:DAC:SAVE)

Command	:SYSTem:REF:DAC:SAVE <file_name>
Format	
Instruction	Save the ref osc code in file.
Parameter Type	String
Parameter Range	None
Return	None
Default	None
Menu	Utility > Setting > 10M Adjustment
Example	:SYSTem:REF:DAC:SAVE "Local/test.dac" :SYSTem:REF:DAC:SAVE "U-disk3/test.dac"

3.2.11 Ref Osc Code Load (:SYSTem:REF:DAC:LOAD)

Command	:SYSTem:REF:DAC:LOAD <file_name>
Format	
Instruction	Load existing ref osc code files.
Parameter	String

SIGLENT

Type	
Parameter Range	None
Return	None
Default	None
Menu	Utility > Setting > 10M Adjustment > Recall Ref Osc Setting
Example	:SYSTem:REF:DAC:LOAD "Local/test.dac" :SYSTem:REF:DAC:LOAD "U-disk3/test.dac"

3.2.12 Reset Ref Osc Code to Default (:SYSTem:REF:DAC:DEFault)

Command Format	:SYSTem:REF:DAC:DEFault
Instruction	Reset ref osc code to default value.
Parameter Type	None
Parameter Range	None
Return	None
Default	None
Menu	Utility > Setting > 10M Adjustment > Reset to Default
Example	:SYSTem:REF:DAC:DEFault

3.3 Preset Subsystem

3.3.1 Preset (:SOURce:PRESet)

Command Format	:SOURce:PRESet
Instruction	Presets all parameters which are related to the selected signal path
Parameter Type	None
Return	None
Default	None
Menu	None

Example	SOUR:PRES
---------	-----------

3.3.1 System Preset (:SYSTem:PRESet)

Command Format	:SYSTem:PRESet
Instruction	Presets all parameters
Parameter Type	None
Return	None
Default	None
Menu	Utility > Preset
Example	SYSTem:PRES

3.3.2 Preset Save (:SYSTem:PRESet:SAVE)

Command Format	:SYSTem:PRESet:SAVE
Instruction	Save status for preset when preset type is user
Parameter Type	None
Return	None
Default	None
Menu	Utility > Preset
Example	:SYSTem:PRESet:SAVE

3.3.3 Preset Path (:SYSTem:PRESet:PATH)

Command Format	:SYSTem:PRESet:PATH <path>
Instruction	Set preset file when preset type is user
Parameter Type	String
Return	None
Default	None
Menu	Utility > Preset
Example	:SYSTem:PRESet:PATH "Local/test.xml" :SYSTem:PRESet:PATH "U-disk1/test.xml"

3.3.4 Preset Type (:SYSTem:PRESet:TYPE)

Command	:SYSTem:PRESet:TYPE DFT USER
Format	:SYSTem:PRESet:TYPE?
Instruction	Uses this command to preset the signal generator to default, user. Get preset type
Parameter Type	Enumeration
Parameter Range	DFT: Default USER: Custom Configuration
Return	Enumeration
Default	DFT
Menu	Utility > Setting > Preset Type
Example	:SYSTem:PRESet:TYPE DFT

3.3.5 Factory Reset (:SYSTem:FDEFault)

Command	:SYSTem:FDEFault
Format	
Instruction	Set both the measure and setting parameters to the factory preset parameters
Parameter Type	None
Parameter Range	None
Return	None
Default	None
Menu	None
Example	:SYSTem:FDEFault

3.4 Output Subsystem

3.4.1 RF Output (:OUTPut[:STATe])

Command	:OUTPut[:STATe] ON OFF 1 0
Format	:OUTPut[:STATe]?
Instruction	Activate/Deactivate the RF output Get the state of the RFoutput

Parameter Type	Boolean
Parameter Range	ON OFF 1 0
Return	Boolean
Default	0
Menu	RF
Example	:OUTPut ON

3.5 Source Subsystem

3.5.1 [:SOURce]:FREQuency Subsystem

3.5.1.1 Frequency Display ([:SOURce]:FREQuency:DISPlay)

Command	[:SOURce]:FREQuency:DISPlay <freq>
Format	[:SOURce]:FREQuency:DISPlay?
Instruction	Set the frequency display on parameter bar Get the frequency display on parameter bar
Parameter Type	Float, unit: Hz, kHz, MHz, GHz, Default "Hz"
Parameter Range	Frequency offset + Full frequency range
Return	Float, unit: Hz
Default	Maximum frequency
Menu	Freq
Example	FREQuency:DISPlay 2 MHz

3.5.1.2 Frequency ([:SOURce]:FREQuency[:FIX])

Command	[:SOURce]:FREQuency[:FIX] <freq>
Format	[:SOURce]:FREQuency[:FIX]?
Instruction	Set the frequency of the RF output signal Get the frequency of the RF output signal
Parameter Type	Float, unit: Hz, kHz, MHz, GHz, Default "Hz"

SIGLENT

Parameter Range	Full frequency range
Return	Float, unit: Hz
Default	Maximum frequency
Menu	FREQ > Frequency
Example	FREQuency 2 MHz

3.5.1.3 Frequency Offset ([:SOURce]:FREQuency:OFFSet)

Command	[:SOURce]:FREQuency:OFFSet <freq>
Format	[:SOURce]:FREQuency:OFFSet?
Instruction	Set the frequency offset of a downstream circuit element Get the frequency offset of a downstream circuit element
Parameter Type	Float, unit: Hz, kHz, MHz, GHz, Default "Hz"
Parameter Range	-200 GHz ~ 200 GHz
Return	Float, unit: Hz
Default	0 Hz
Menu	FREQ > Freq Offset
Example	FREQuency:OFFSet 2 MHz

3.5.1.4 Phase Offset ([:SOURce]:PHASe)

Command	[:SOURce]:PHASe <phase>
Format	[:SOURce]:PHASe?
Instruction	Set the phase of the RF output signal Get the phase of the RF output signal
Parameter Type	Float, unit: deg
Parameter Range	-360 deg ~ 360 deg
Return	Float, unit: deg
Default	0 deg
Menu	FREQ > Phase Offset
Example	PHASe 20

3.5.1.5 Phase Reset ([:SOURce]:PHASe:RESet [:SOURce]:PHASe:REF)

Command	[:SOURce]:PHASe:RESet
Format	[:SOURce]:PHASe:REF
Instruction	Set the current phase to zero
Parameter Type	None
Parameter Range	None
Return	None
Default	None
Menu	FREQ > Reset phase delta display
Example	:PHASe:RESet

3.5.2 [:SOURce]:POWER Subsystem

3.5.2.1 Level Display ([:SOURce]:POWER:POWER)

Command	[:SOURce]:POWER:POWER <power>
Format	[:SOURce]:POWER:POWER?
Instruction	Set the RF level display on parameter bar Get the RF level display from the parameter bar
Parameter Type	Float, unit: dBm, dBmV, dBuV, V, W, Default: dBm
Parameter Range	Level Offset + Full power range
Return	Float, unit: dBm
Default	-130 dBm
Menu	Level
Example	POWER:POWER 2

3.5.2.2 Level ([:SOURce]:POWER)

Command	[:SOURce]:POWER <power>
Format	[:SOURce]:POWER?

SIGLENT

Instruction	Set the RF output level Get the RF output level
Parameter Type	Float, unit: dBm, dBmV, dBuV, V, W
Parameter Range	When IQ is switched on: -100 dBm ~ 10 dBm Frequency between 9 kHz ~ 100 kHz: -110 dBm ~ 9 dBm Frequency between 100 kHz ~ 1 MHz: -110 dBm ~ 15 dBm Frequency above 1 MHz: -110 dBm ~ 20 dBm
Return	Float, unit: dBm
Default	-130 dBm
Menu	LEVEL > Level
Example	POWER 2

3.5.2.3 Level Offset ([:SOURce]:POWER:OFFSet)

Command	[:SOURce]:POWER:OFFSet <power>
Format	[:SOURce]:POWER:OFFSet?
Instruction	Set the RF offset level of the RF output Get the RF offset level of the RF output
Parameter Type	Float
Parameter Range	-100 dB ~ 100 dB
Return	Float, unit: dB
Default	0 dB
Menu	LEVEL > Level Offset
Example	POWER:OFFSet 2

3.5.2.4 ALC State ([:SOURce]:POWER:ALC)

Command	[:SOURce]:POWER:ALC ON OFF AUTO
Format	[:SOURce]:POWER:ALC?
Instruction	Activate/deactivate automatic level control. Query ALC state
Parameter Type	Enumeration
Parameter	ON OFF AUTO

Range	ON Internal level control is permanently activated. OFF Internal level control is deactivated; Sample & Hold mode is activated. AUTO Internal level control is activated/deactivated automatically depending on the operating state.
Return	Enumeration
Default	AUTO
Menu	LEVEL > ALC State
Example	POWER:ALC ON

3.5.2.5 Flatness List State ([:SOURce]:CORRection[:FLATness])

Command	[:SOURce]:CORRection[:FLATness] ON OFF 1 0
Format	[:SOURce]:CORRection[:FLATness]?
Instruction	Activate/deactivate flatness correction list.
Parameter Type	Boolean
Parameter Range	ON OFF 1 0
Return	Boolean
Default	0
Menu	LEVEL > Flatness
Example	CORRection:FLATness ON

3.5.2.6 Flatness List Add Row

([:SOURce]:CORRection:FLATness:PAIR)

Command Format	[:SOURce]:CORRection:FLATness:PAIR <freq>,<power>
Instruction	Insert a new row in the flatness list.
Parameter Type	Float, Float
Parameter Range	Freq: Full freq range Power: Full power range

SIGLENT

Return	None
Default	None
Menu	LEVEL > Flatness > [+]
Example	CORRection:FLATness:PAIR 1 MHz,1

3.5.2.7 Flatness List Delete Row

([:SOURce]:CORRection:FLATness:DELeTe)

Command Format	[:SOURce]:CORRection:FLATness:DELeTe <row>
Instruction	Delete the selected row in the flatness list.
Parameter Type	Integer
Parameter Range	Less than the total count of the flatness.
Return	None
Default	None
Menu	LEVEL > Flatness > [-]
Example	CORRection:FLATness:DELeTe 0

3.5.2.8 Flatness List Count

([:SOURce]:CORRection:FLATness:COUNT?)

Command Format	[:SOURce]:CORRection:FLATness:COUNT?
Instruction	Indicates the total count of the number of elements in the flatness correction table
Parameter Type	None
Parameter Range	None
Return	Integer
Default	0
Menu	LEVEL > Flatness
Example	CORRection:FLATness:COUNT?

3.5.2.9 Flatness List Store ([:SOURce]:CORRection:STORe)

Command Format	[:SOURce]:CORRection:STORe <file_name>
Instruction	Save the correction data in the list
Parameter Type	String
Parameter Range	None
Return	None
Default	None
Menu	LEVEL > Flatness > Store
Example	:CORRection:STORe "U-disk3/test.uflt" :CORRection:STORe "Local /test.uflt"

3.5.2.10 Flatness List Load ([:SOURce]:CORRection:LOAD)

Command Format	[:SOURce]:CORRection:LOAD <file_name>
Instruction	Load an existing flatness correction file
Parameter Type	String
Parameter Range	None
Return	None
Default	None
Menu	LEVEL > Flatness > Load
Example	:CORRection:LOAD "U-disk3/test.uflt" :CORRection:LOAD "Local/test.uflt"

3.5.2.11 Flatness List Clear

([:SOURce]:CORRection:FLATness:PRESet)

Command Format	[:SOURce]:CORRection:FLATness:PRESet
Instruction	Clear the displayed flatness correction list

SIGLENT

Parameter Type	None
Parameter Range	None
Default	None
Menu	LEVEL > Flatness > Clear
Example	:CORRection:FLATness:PRESet

3.5.2.12 Flatness List Fill Type

([:SOURce]:CORRection:FLATness:FILL:TYPE)

Command	[:SOURce]:CORRection:FLATness:FILL:TYPE FLATness MANUal SWEEPlist
Format	[:SOURce]:CORRection:FLATness:FILL:TYPE?
Instruction	Set the Fill Type to generate flatness list. Get the Fill Type to generate flatness list.
Parameter Type	Enumeration
Parameter Range	FLATness MANUal SWEEPlist
Return	Enumeration
Default	FLATness
Menu	LEVEL > Flatness > Set > Fill Type
Example	:CORRection:FLATness:FILL:TYPE FLATness

3.5.2.13 Flatness List Start Freq

([:SOURce]:CORRection:FLATness:STARTfreq)

Command	[:SOURce]:CORRection:FLATness:STARTfreq <freq>
Format	[:SOURce]:CORRection:FLATness:STARTfreq?
Instruction	Set the start frequency when you want to fill the flatness list with the sensor and filling type is "Manual Step". Get the start frequency when you want to fill the flatness list with the sensor and filling type is "Manual Step".
Parameter Type	Float, unit: Hz, kHz, MHz, GHz, Default "Hz"
Parameter	Full frequency range

Range	
Return	Float, unit: Hz
Default	Maximum frequency
Menu	LEVEL > Flatness > Set > Fill Type > Manual Step
Example	:CORRection:FLATness:STARtfreq 200 MHz

3.5.2.14 Flatness List Stop Freq

([:SOURce]:CORRection:FLATness:STOPfreq)

Command	[:SOURce]:CORRection:FLATness:STOPfreq <freq>
Format	[:SOURce]:CORRection:FLATness:STOPfreq?
Instruction	Set the stop frequency when you want to fill the flatness list with the sensor and filling type is "Manual Step". Get the stop frequency when you want to fill the flatness list with the sensor and filling type is "Manual Step".
Parameter Type	Float, unit: Hz, kHz, MHz, GHz, Default "Hz"
Parameter Range	Full frequency range
Return	Float, unit: Hz
Default	Maximum frequency
Menu	LEVEL > Flatness > Set > Fill Type > Manual Step
Example	:CORRection:FLATness:STOPfreq 500 MHz

3.5.2.15 Flatness List Fill Space

([:SOURce]:CORRection:FLATness:LINStep)

Command	[:SOURce]:CORRection:FLATness:SPACE LINear LOGarithmic
Format	[:SOURce]:CORRection:FLATness:SPACE?
Instruction	Set the fill space in Manual Step Fill Type. Get the fill space in Manual Step Fill Type.
Parameter Type	Enumeration
Parameter Range	LINear LOGarithmic
Return	Enumeration

SIGLENT

Default	LINear
Menu	LEVEL > Flatness > Set > Fill Type > Manual Step
Example	:CORRection:FLATness:SPACe LINear

3.5.2.16 Flatness List Linear Step

([:SOURce]:CORRection:FLATness:LINStep)

Command	[:SOURce]:CORRection:FLATness:LINStep <freq>
Format	[:SOURce]:CORRection:FLATness:LINStep?
Instruction	Set the linear frequency step in Manual Step Fill Type. Get the linear frequency step in Manual Step Fill Type.
Parameter Type	Float, unit: Hz, kHz, MHz, GHz, Default "Hz"
Parameter Range	None
Return	Float, unit: Hz
Default	None
Menu	LEVEL > Flatness > Set > Fill Type > Manual Step
Example	:CORRection:FLATness:LINStep 200 MHz

3.5.2.17 Flatness List Log Step

([:SOURce]:CORRection:FLATness:LOGStep)

Command	[:SOURce]:CORRection:FLATness:LOGStep <value>
Format	[:SOURce]:CORRection:FLATness:LOGStep?
Instruction	Set the log frequency step in Manual Step Fill Type. Get the log frequency step in Manual Step Fill Type.
Parameter Type	Float, unit: %
Parameter Range	None
Return	Float, unit: %
Default	None
Menu	LEVEL > Flatness > Set > Fill Type > Manual Step
Example	:CORRection:FLATness:LOGStep 20

3.5.2.18 Flatness List Points

([:SOURce]:CORRection:FLATness:POINT)

Command	[:SOURce]:CORRection:FLATness:POINT <points>
Format	[:SOURce]:CORRection:FLATness:POINT?
Instruction	Set the points of flatness list in Manual Step Fill Type. Get the points of flatness list in Manual Step Fill Type.
Parameter Type	Integer
Parameter Range	2 ~ 500
Return	Integer
Default	11
Menu	LEVEL > Flatness > Set > Fill Type > Manual Step
Example	:CORRection:FLATness:POINT 5

3.5.2.19 Level Control ([:SOURce]:POWER:SPC:STATe)

Command	[:SOURce]:POWER:SPC:STATe ON OFF 1 0
Format	[:SOURce]:POWER:SPC:STATe?
Instruction	Activate/Deactivate power control using an external USB power sensor Get the level control state
Parameter Type	Boolean
Parameter Range	ON OFF 1 0
Return	Boolean
Default	0
Menu	SENSOR > Level Control
Example	POWER:SPC:STATe ON

3.5.2.20 Target Level ([:SOURce]:POWER:SPC:TARGet)

Command	[:SOURce]:POWER:SPC:TARGet <power>
Format	[:SOURce]:POWER:SPC:TARGet?
Instruction	Set the nominal level expected at the input of the sensor

SIGLENT

	Get the nominal level expected at the input of the sensor
Parameter Type	Float, unit: dBm, dBmV, dBuV, V, W, Default: dBm
Parameter Range	-120 dBm ~ 20 dBm
Return	Float, unit: dBm
Default	0 dBm
Menu	SENSOR > Level Control > Target Level
Example	POWER:SPC:TARGet 0

3.5.2.21 Level Limit ([:SOURce]:POWER:LIMit)

Command	[:SOURce]:POWER:LIMit <power>
Format	[:SOURce]:POWER:LIMit?
Instruction	Set the upper limit for the RF output power Get the upper limit for the RF output power
Parameter Type	Float, unit: dBm, dBmV, dBuV, V, W, Default: dBm
Parameter Range	-120 dBm ~ 20 dBm
Return	Float, unit: dBm
Default	0 dBm
Menu	SENSOR > Level Control > Level Limit
Example	POWER:LIMit 1

3.5.2.22 Catch Range ([:SOURce]:POWER:SPC:CRANge)

Command	[SOURce]:POWER:SPC:CRANge <power>
Format	[SOURce]:POWER:SPC:CRANge?
Instruction	Set the capture range of the control system Get the capture range of the control system
Parameter Type	Float
Parameter Range	0 dB ~ 50 dB
Return	Float, unit: dB
Default	0 dB

Menu	SENSOR > Level Control > Catch Range
Example	:POWer:SPC:CRANge 5

3.5.3 [:SOURce]:SWEep Subsystem

3.5.3.1 Sweep State ([:SOURce]:SWEep:STATe)

Command	[:SOURce]:SWEep:STATe OFF FREQuency LEVe LEV_FREQ
Format	[:SOURce]:SWEep:STATe?
Instruction	Activate frequency or/and level sweep
Parameter Type	Enumeration
Parameter Range	OFF FREQuency LEVe LEV_FREQ
Return	Enumeration
Default	OFF
Menu	SWEEP > Sweep State
Example	:SWEep:STATe OFF

3.5.3.2 Sweep Type ([:SOURce]:SWEep:TYPE)

Command	[:SOURce]:SWEep:TYPE LIST STEP
Format	[:SOURce]:SWEep:TYPE?
Instruction	Set sweep type Get sweep type
Parameter Type	Enumeration
Parameter Range	LIST STEP
Return	Enumeration
Default	STEP
Menu	SWEEP > Step Sweep / List Sweep
Example	:SWEep:TYPE STEP

3.5.3.3 Start Frequency

([:SOURce]:SWEep:STEP:START:FREQuency)

Command	[:SOURce]:SWEep:STEP:START:FREQuency <freq>
Format	[:SOURce]:SWEep:STEP:START:FREQuency?
Instruction	Set the start frequency for the sweep mode Get the start frequency for the sweep mode
Parameter Type	Float, unit: Hz, kHz, MHz, GHz, Default "Hz"
Parameter Range	Full frequency range.
Return	Float, unit: Hz
Default	Maximum frequency
Menu	SWEEP > Step Sweep > Start Freq
Example	:SWEep:STEP:START:FREQuency 1 GHz

3.5.3.4 Stop Frequency

([:SOURce]:SWEep:STEP:STOP:FREQuency)

Command	[:SOURce]:SWEep:STEP:STOP:FREQuency <freq>
Format	[:SOURce]:SWEep:STEP:STOP:FREQuency?
Instruction	Set the stop frequency for the sweep mode Get the stop frequency for the sweep mode
Parameter Type	Float, unit: Hz, kHz, MHz, GHz, Default "Hz"
Parameter Range	Full frequency range.
Return	Float, unit: Hz
Default	Maximum frequency
Menu	SWEEP > Step Sweep > Stop Freq
Example	:SWEep:STEP:STOP:FREQuency 1 GHz

3.5.3.5 Start Level ([:SOURce]:SWEep:STEP:START:LEVel)

Command	[:SOURce]:SWEep:STEP:START:LEVel <level>
Format	[:SOURce]:SWEep:STEP:START:LEVel?

Instruction	Set the start level for the sweep mode Get the start level for the sweep mode
Parameter Type	Float, unit: dBm, dBmV, dBuV, V, W, Default: dBm
Parameter Range	Full level range.
Return	Float, unit: dBm
Default	-130 dBm
Menu	SWEEP > Step Sweep > Start Level
Example	:SWEep:STEP:START:LEVel 0 dBm

3.5.3.6 Stop Level ([:SOURce]:SWEep:STEP:STOP:LEVel)

Command	[:SOURce]:SWEep:STEP:STOP:LEVel <level>
Format	[:SOURce]:SWEep:STEP:STOP:LEVel?
Instruction	Set the stop level for the sweep mode Get the stop level for the sweep mode
Parameter Type	Float, unit: dBm, dBmV, dBuV, V, W, Default dBm
Parameter Range	Full level range.
Return	Float, unit: dBm
Default	-130 dBm
Menu	SWEEP > Step Sweep > Stop Level
Example	:SWEep:STEP:STOP:LEVel 0 dBm

3.5.3.7 Dwell Time ([:SOURce]:SWEep:STEP:DWELI)

Command	[:SOURce]:SWEep:STEP:DWELI <time>
Format	[:SOURce]:SWEep:STEP:DWELI?
Instruction	Set the duration of the individual sweep steps Get the duration of the individual sweep steps
Parameter Type	Float, unit: ns, us, ms, s
Parameter Range	10 ms ~ 100 s
Return	Float, unit: s

SIGLENT

Default	30 ms
Menu	SWEEP > Step Sweep > Dwell Time
Example	:SWEep:STEP:DWELI 20 ms

3.5.3.8 Sweep Points ([:SOURce]:SWEep:STEP:POINts)

Command	[:SOURce]:SWEep:STEP:POINts <points>
Format	[:SOURce]:SWEep:STEP:POINts?
Instruction	Set the number of steps in an RF sweep Get the number of steps in an RF sweep
Parameter Type	Integer
Parameter Range	2 ~ 65535
Return	Integer
Default	11
Menu	SWEEP > Step Sweep > Sweep Points
Example	:SWEep:STEP:POINts 2

3.5.3.9 Sweep Shape ([:SOURce]:SWEep:STEP:SHAPE)

Command	[:SOURce]:SWEep:STEP:SHAPE TRIangle SAWtooth
Format	[:SOURce]:SWEep:STEP:SHAPE?
Instruction	Select the waveform shape of the sweep signal Get the waveform shape of the sweep signal
Parameter Type	Enumeration
Parameter Range	TRIangle SAWtooth
Return	Enumeration
Default	SAWTooth
Menu	SWEEP > Step Sweep > Sweep Shape
Example	:SWEep:STEP:SHAPE TRIangle

3.5.3.10 Sweep Space ([:SOURce]:SWEep:STEP:SPACE)

Command	[:SOURce]:SWEep:STEP:SPACE LINear LOGarithmic
---------	---

Format	[[:SOURce]:SWEep:STEP:SPACe?
Instruction	Select the sweep spacing Get the sweep spacing
Parameter Type	Enumeration
Parameter Range	LINear LOGarithmic
Return	Enumeration
Default	LINear
Menu	SWEEP > Step Sweep > Sweep Space
Example	:SWEep:STEP:SPACe LOGarithmic

3.5.3.11 Sweep Step in Linear Sweep Space

([:SOURce]:SWEep[:FREQUENCY]:STEP[:LINear])

Command	[[:SOURce]:SWEep[:FREQUENCY]:STEP[:LINear] <freq>
Format	[[:SOURce]:SWEep[:FREQUENCY]:STEP[:LINear]?
Instruction	Set the sweep step in linear sweep space. Get the sweep step in linear sweep space.
Parameter Type	Float, unit: Hz, kHz, MHz, GHz, Default "Hz"
Parameter Range	None
Return	Float, unit: Hz
Default	0
Menu	SWEEP > Step Sweep > Freq Step Linear
Example	:SWEep:STEP 200 MHz

3.5.3.12 Sweep Step in Log Sweep Space

([:SOURce]:SWEep[:FREQUENCY]:STEP:LOGarithmic)

Command	[[:SOURce]:SWEep[:FREQUENCY]:STEP:LOGarithmic <value>
Format	[[:SOURce]:SWEep[:FREQUENCY]:STEP:LOGarithmic?
Instruction	Set the sweep step in logarithmic sweep space. Get the sweep step in logarithmic sweep space.
Parameter	Float, unit: %

SIGLENT

Type	
Parameter Range	None
Return	Float, unit: %
Default	0
Menu	SWEEP > Step Sweep > Freq Step Log
Example	:SWEep:STEP:LOGarithmic 20

3.5.3.13 Sweep List Add Row ([:SOURce]:SWEep:LIST:ADDList)

Command Format	[:SOURce]:SWEep:LIST:ADDList <freq>,<level>,<time>
Instruction	Insert a new row to the list
Parameter Type	Freq: Float, unit: Hz, kHz, MHz, GHz, Default "Hz" Level: Float, unit: dBm Time: Float, unit: ns, us, ms, s
Parameter Range	Full frequency range, full frequency range, 10.0 ms ~ 100.0 s
Return	None
Default	None
Menu	SWEEP > List Sweep > [+]
Example	:SWEep:LIST:ADDList 1 GHz,0 dBm,1 s

3.5.3.14 Sweep List Delete Row ([:SOURce]:SWEep:LIST:DELeTe)

Command Format	[:SOURce]:SWEep:LIST:DELeTe <row>
Instruction	Delete the sweep list pair
Parameter Type	Integer
Parameter Range	1 to the full count of the sweep list.
Return	None
Default	None
Menu	SWEEP > List Sweep > [-]
Example	:SWEep:LIST:DELeTe 1

3.5.3.15 Sweep List Edit ([:SOURce]:SWEep:LIST:CHANGe)

Command Format	[:SOURce]:SWEep:LIST:CHANGe <row>,<freq>,<power>,<time>
Instruction	Edit sweep list pair value
Parameter Type	Integer, Float, unit: Hz, kHz, MHz, GHz, Float, unit: dBm, dBmV, dBuV, V, W, Default: dBm, Float, unit: ns, us, ms, s
Parameter Range	Raw: 1 ~ count of pair. Freq: Full frequency range. Power: Full level range. time: 10 ms ~ 100 s.
Return	None
Default	None
Menu	SWEEP > List Sweep
Example	:SWEep:LIST:CHANGe 1,1 GHz,1 dBm, 1 s

3.5.3.16 Sweep List Row Count ([:SOURce]:SWEep:LIST:CPOint?)

Command Format	[:SOURce]:SWEep:LIST:CPOint?
Instruction	Get how many rows in sweep list
Parameter Type	None
Parameter Range	None
Return	Float
Default	1
Menu	SWEEP > List Sweep
Example	:SWEep:LIST:CPOint?

3.5.3.17 Show Sweep List ([:SOURce]:SWEep:LIST:LIST?)

Command Format	[:SOURce]:SWEep:LIST:LIST? <begin_row>,<end_row>
Instruction	View starting row to end row data
Parameter Type	Integer, Integer

SIGLENT

Parameter Range	1 to count of sweep list.
Return	String
Default	None
Menu	SWEEP > List Sweep
Example	:SWEep:LIST:LIST? 1,3

3.5.3.18 Sweep List Clear

([:SOURce]:SWEep:LIST:INITialize:PRESet)

Command Format	[:SOURce]:SWEep:LIST:INITialize:PRESet
Instruction	Restore the scan list of the factory default settings
Parameter Type	None
Parameter Range	None
Return	None
Default	None
Menu	SWEEP > List Sweep > Clear
Example	SWEep:LIST:INITialize:PRESet

3.5.3.19 Sweep List Initialize From Step

([:SOURce]:SWEep:LIST:INITialize:FSTep)

Command Format	[:SOURce]:SWEep:LIST:INITialize:FSTep
Instruction	Regenerate the sweep list based on the data points of the current step sweep settings
Parameter Type	None
Parameter Range	None
Return	None
Default	None
Menu	SWEEP > List Sweep

Example	SWEep:LIST:INITialize:FSTep
---------	-----------------------------

3.5.3.20 Sweep List Load ([:SOURce]:SWEep:LOAD)

Command Format	[:SOURce]: SWEep:LOAD <file_name>
Instruction	Load existing sweep list file
Parameter Type	String
Parameter Range	None
Return	None
Default	None
Menu	SWEEP > List Sweep > Load
Example	:SWEep:LOAD "U-disk3/test.lsw" :SWEep:LOAD "Local/test.lsw"

3.5.3.21 Sweep List Store ([:SOURce]:SWEep:STORE)

Command Format	[:SOURce]: SWEep:STORE <file_name>
Instruction	Save the sweep data in the list
Parameter Type	String
Parameter Range	None
Return	None
Default	None
Menu	SWEEP > List Sweep > Store
Example	:SWEep:STORE "U-disk3/test.lsw" :SWEep:STORE "Local/test.lsw"

3.5.3.22 Sweep Direction ([:SOURce]:SWEep:DIRect)

Command Format	[:SOURce]:SWEep:DIRect FWD REV
Instruction	Select the direction for sweep

SIGLENT

Parameter Type	Enumeration
Parameter Range	FWD REV
Return	Enumeration
Default	FWD
Menu	SWEEP > Direction
Example	:SWEep:DIRect REV

3.5.3.23 Sweep Mode ([:SOURce]:SWEep:MODE)

Command	[:SOURce]:SWEep:MODE CONTInue SINGle
Format	[:SOURce]:SWEep:MODE?
Instruction	Set the cycle mode of the sweep Get the cycle mode of the sweep
Parameter Type	Enumeration
Parameter Range	CONTInue SINGle
Return	Enumeration
Default	CONTInue
Menu	SWEEP > Sweep Mode
Example	:SWEep:MODE SINGle

3.5.3.24 Trigger Mode ([:SOURce]:SWEep:SWEep:TRIGger:TYPE)

Command	[:SOURce]:SWEep:SWEep:TRIGger:TYPE AUTO KEY BUS EXT
Format	[:SOURce]:SWEep:SWEep:TRIGger:TYPE?
Instruction	Select the trigger mode Get the trigger mode
Parameter Type	Enumeration
Parameter Range	AUTO KEY BUS EXT
Return	Enumeration
Default	AUTO
Menu	SWEEP > Trigger Mode

Example	:SWEep:SWEep:TRIGger:TYPE KEY
---------	-------------------------------

3.5.3.25 Point Trigger ([:SOURce]:SWEep:POINT:TRIGger:TYPE)

Command	[:SOURce]:SWEep:POINT:TRIGger:TYPE AUTO KEY BUS EXT
Format	[:SOURce]:SWEep:POINT:TRIGger:TYPE?
Instruction	Select the point trigger Get the point trigger
Parameter Type	Enumeration
Parameter Range	AUTO KEY BUS EXT
Return	Enumeration
Default	AUTO
Menu	SWEEP > Point Trigger
Example	:SWEep:POINT:TRIGger:TYPE KEY

3.5.3.26 Trigger Slope ([:SOURce]:INPut:TRIGger:SLOPe)

Command	[:SOURce]:INPut:TRIGger:SLOPe POSitive NEGative
Format	[:SOURce]:INPut:TRIGger:SLOPe?
Instruction	Select the trigger slope Get the trigger slope
Parameter Type	Enumeration
Parameter Range	POSitive NEGative
Return	Enumeration
Default	POSitive
Menu	SWEEP > Trigger Slope
Example	:INPut:TRIGger:SLOPe NEGative

3.5.4 [:SOURce]:MODulation Subsystem

3.5.4.1 Modulation State ([:SOURce]:MODulation)

Command	[:SOURce]:MODulation ON OFF 1 0
---------	---------------------------------

SIGLENT

Format	[[:SOURce]:MODulation?
Instruction	Switch modulation on and off Get the modulation state
Parameter Type	Boolean
Parameter Range	ON OFF 1 0
Return	Boolean
Default	0
Menu	MOD
Example	MODulation ON

3.5.5 [:SOURce]:AM Subsystem

3.5.5.1 AM State ([:SOURce]:AM:STATe)

Command	[[:SOURce]:AM:STATe ON OFF 1 0
Format	[[:SOURce]:AM:STATe?
Instruction	Activate/Deactivate amplitude modulation (AM) Get the AM state
Parameter Type	Boolean
Parameter Range	ON OFF 1 0
Return	Boolean
Default	0
Menu	AM > AM State
Example	:AM:STATe ON

3.5.5.2 AM Shape ([:SOURce]:AM:WAVEform)

Command	[[:SOURce]:AM:WAVEform SINE SQUAre
Format	[[:SOURce]:AM:WAVEform?
Instruction	Set the AM modulation waveform Get the AM modulation waveform
Parameter	Enumeration

Type	
Parameter Range	SINE SQUAre
Return	Enumeration
Default	SINE
Menu	AM > AM Shape
Example	:AM:WAVEform SINE

3.5.5.3 AM Source ([:SOURce]:AM:SOURce)

Command	[:SOURce]:AM:SOURce INTernal EXTernal INT,EXT
Format	[:SOURce]:AM:SOURce?
Instruction	Select the modulation signal source for amplitude modulation Get the AM source
Parameter Type	Enumeration
Parameter Range	INTernal EXTernal INT,EXT
Return	Enumeration
Default	INTernal
Menu	AM > AM Source
Example	:AM:SOURce EXTernal

3.5.5.4 AM Depth ([:SOURce]:AM:DEPTH)

Command	[:SOURce]:AM:DEPTTh <value>
Format	[:SOURce]:AM:DEPTTh?
Instruction	Set the overall modulation depth of the amplitude modulation in percent Get the AM depth
Parameter Type	Float
Parameter Range	0.1 % ~ 100 %
Return	Float
Default	50 %
Menu	AM > AM Depth
Example	:AM:DEPTTh 0.2

3.5.5.5 AM Rate ([:SOURce]:AM:FREQuency)

Command	[:SOURce]:AM:FREQuency <value>
Format	[:SOURce]:AM:FREQuency?
Instruction	Set the AM modulation frequency Get the AM modulation frequency
Parameter Type	Float, unit: Hz, kHz, MHz, GHz, Default "Hz"
Parameter Range	Sine: 0.01 Hz ~ 100 kHz Square: 0.01 Hz ~ 20 kHz
Return	Float, unit: Hz
Default	1 kHz
Menu	AM > AM Rate
Example	:AM:FREQuency 10 kHz

3.5.5.6 AM Sensitivity ([:SOURce]:AM:SENSitivity)

Command Format	[:SOURce]:AM:SENSitivity?
Instruction	Query the input sensitivity of the external modulation input in %/V
Parameter Type	None
Parameter Range	None
Return	Float, unit: %/V
Default	0 %/V
Menu	AM > AM Sensitivity
Example	AM:SENSitivity?

3.5.6 [:SOURce]:FM Subsystem

3.5.6.1 FM State ([:SOURce]:FM:STATe)

Command	[:SOURce]:FM:STATe ON OFF 1 0
Format	[:SOURce]:FM:STATe?
Instruction	Activate/Deactivate frequency modulation (FM)

	Get the FM state
Parameter Type	Boolean
Parameter Range	ON OFF 1 0
Return	Boolean
Default	0
Menu	FM > FM State
Example	:FM:STATE ON

3.5.6.2 FM Shape ([:SOURce]:FM:WAVEform)

Command	[:SOURce]:FM:WAVEform SINE SQUAre
Format	[:SOURce]:FM:WAVEform?
Instruction	Selects the shape of the FM waveform Get the shape of the FM waveform
Parameter Type	Enumeration
Parameter Range	SINE SQUAre
Return	Enumeration
Default	SINE
Menu	FM > FM Shape
Example	:FM:WAVEform SQUAre

3.5.6.3 FM Source ([:SOURce]:FM:SOURce)

Command	[:SOURce]:FM:SOURce INTernal EXTernal INT,EXT
Format	[:SOURce]:FM:SOURce?
Instruction	Select the modulation signal source for frequency modulation (FM) Get the FM Source
Parameter Type	Enumeration
Parameter Range	INTernal EXTernal INT,EXT
Return	Enumeration
Default	INTernal

SIGLENT

Menu	FM > FM Source
Example	:FM:SOURce EXTernal

3.5.6.4 FM Deviation ([:SOURce]:FM:DEVIation)

Command	[:SOURce]:FM:DEVIation <value>
Format	[:SOURce]:FM:DEVIation?
Instruction	Set the FM deviation value Get the FM deviation value
Parameter Type	Float, unit: Hz, kHz, MHz, GHz
Parameter Range	0.01 Hz ~ 1 MHz
Return	Float, unit: Hz
Default	100 kHz
Menu	FM > FM Deviation
Example	:FM:DEVIation 500 kHz

3.5.6.5 FM Rate ([:SOURce]:FM:FREQuency)

Command	[:SOURce]:FM:FREQuency <value>
Format	[:SOURce]:FM:FREQuency?
Instruction	Set the FM modulation frequency Get the FM modulation frequency
Parameter Type	Float, unit: Hz, kHz, MHz, GHz, Default "Hz"
Parameter Range	INTernal: SQUAre: 0.01 Hz ~ 20 kHz SINE: 0.01 Hz ~ 100 kHz INT+EXT: SQUAre: 0.01 Hz ~ 20 kHz SINE: 0.01 Hz ~ 100 kHz
Return	Float, unit: Hz
Default	10 kHz
Menu	FM > FM Rate
Example	:FM:FREQuency 40 kHz

3.5.6.6 FM Sensitivity ([:SOURce]:FM:SENSitivity)

Command Format	[:SOURce]:FM:SENSitivity?
----------------	---------------------------

Instruction	Displays the input sensitivity of the FM EXT input in Hz/V
Parameter Type	None
Parameter Range	None
Return	Float unit: Hz/V
Default	0 Hz/V
Menu	FM > FM Sensitivity
Example	FM:SENSitivity?

3.5.7 [:SOURce]:PM Subsystem

3.5.7.1 PM State ([:SOURce]:PM:STATe)

Command	[:SOURce]:PM:STATe ON OFF 1 0
Format	[:SOURce]:PM:STATe?
Instruction	Activate/Deactivate phase modulation (PM) Get the PM state
Parameter Type	Boolean
Parameter Range	ON OFF 1 0
Return	Boolean
Default	0
Menu	PM > PM State
Example	:PM:STATe ON

3.5.7.2 PM Shape ([:SOURce]:PM:WAVEform)

Command	[:SOURce]:PM:WAVEform SINE SQUAre
Format	[:SOURce]:PM:WAVEform?
Instruction	Selects the shape of PM Get the shape of PM
Parameter Type	Enumeration
Parameter	SINE SQUAre

SIGLENT

Range	
Return	Enumeration
Default	SINE
Menu	PM > PM Shape
Example	:PM:WAVEform SINE

3.5.7.3 PM Source ([:SOURce]:PM:SOURce)

Command	[:SOURce]:PM:SOURce INTernal EXTernal INT,EXT
Format	[:SOURce]:PM:SOURce?
Instruction	Select the modulation signal source for phase modulation (PM) Get the PM source
Parameter Type	Enumeration
Parameter Range	INTernal EXTernal INT,EXT
Return	Enumeration
Default	INTernal
Menu	PM > PM Source
Example	:PM:SOURce EXTernal

3.5.7.4 PM Deviation ([:SOURce]:PM:DEVIation)

Command	[:SOURce]:PM:DEVIation <value>
Format	[:SOURce]:PM:DEVIation?
Instruction	Set the modulation deviation of the phase modulation (PM) Get the modulation deviation of the phase modulation (PM)
Parameter Type	Float, unit: rad
Parameter Range	0.00001 rad ~ 5 rad
Return	Float, unit: rad
Default	1 rad
Menu	PM > PM Deviation
Example	:PM:DEVIation 2

3.5.7.5 PM Rate ([:SOURce]:PM:FREQuency)

Command	[:SOURce]:PM:FREQuency <value>
Format	[:SOURce]:PM:FREQuency?
Instruction	Set the phase modulation (PM) frequency Get the phase modulation (PM) frequency
Parameter Type	Float, unit: Hz, kHz, MHz, GHz, Default "Hz"
Parameter Range	INTernal: SQUAre:0.01 Hz ~ 20 kHz SINE: 0.01 Hz ~ 100 kHz INT+EXT: SQUAre:0.01 Hz ~ 20 kHz 0.01 Hz ~ 100 kHz
Return	Float, unit: Hz
Default	10 kHz
Menu	PM > PM Rate
Example	:PM:FREQuency 10 kHz

3.5.7.6 PM Sensitivity ([:SOURce]:PM:SENSitivity)

Command Format	[:SOURce]:PM:SENSitivity?
Instruction	Query the input sensitivity of the EXT MOD input in rad/v
Parameter Type	None
Parameter Range	None
Return	Float, unit: rad/V
Default	0 rad/V
Menu	PM > PM Sensitivity
Example	PM:SENSitivity?

3.5.8 [:SOURce]:PULM Subsystem

3.5.8.1 Pulse State ([:SOURce]:PULM:STATe)

Command	[:SOURce]:PULM:STATe ON OFF 1 0
Format	[:SOURce]:PULM:STATe?
Instruction	Activate/Deactivate the pulse modulation

SIGLENT

	Get the state of pulse modulation
Parameter Type	Boolean
Parameter Range	ON OFF 1 0
Return	Boolean
Default	0
Menu	PULSE > Pulse State
Example	PULM:STAT ON

3.5.8.2 Pulse Out ([:SOURce]:PULM:OUT:STATe)

Command	[:SOURce]:PULM:OUT:STATe ON OFF 1 0
Format	[:SOURce]:PULM:OUT:STATe?
Instruction	Configures the signal at the PULSE OUT connector Get the Pulse Output status
Parameter Type	Boolean
Parameter Range	ON OFF 1 0
Return	Boolean
Default	0
Menu	PULSE > Pulse Out
Example	PULM:OUT ON

3.5.8.3 Pulse Source ([:SOURce]:PULM:SOURce)

Command	[:SOURce]:PULM:SOURce INTernal EXTernal
Format	[:SOURce]:PULM:SOURce?
Instruction	Select the source for the pulse modulation signal Get the source for the pulse modulation signal
Parameter Type	Enumeration
Parameter Range	INTernal EXTernal
Return	Enumeration
Default	INTernal

Menu	PULSE > Pulse Source
Example	PULM:SOUR INTERNAL

3.5.8.4 Pulse Polarity ([:SOURce]:PULM:POLarity)

Command	[:SOURce]:PULM:POLarity NORMal INVerted
Format	[:SOURce]:PULM:POLarity?
Instruction	Set the period of the generated pulse. The period determines the repetition frequency of the internal signal Get the period of the generated pulse
Parameter Type	Enumeration
Parameter Range	NORMal INVerted
Return	Enumeration
Default	NORMal
Menu	PULSE > Pulse Polarity
Example	PULM:POL INV

3.5.8.5 Pulse Mode ([:SOURce]:PULM:MODE)

Command	[:SOURce]:PULM:MODE SINGLE DOUBle PTRain
Format	[:SOURce]:PULM:MODE?
Instruction	Set the mode of the pulse generator Get the mode of the pulse generator
Parameter Type	Enumeration
Parameter Range	SINGLE DOUBle PTRain SINGLE Enables single pulse generation. DOUBle Enables double pulse generation. The two pulses are generated in one pulse period. PTRain A user-defined pulse train is generated The pulse train is defined by value pairs of on and off times that can be entered in a pulse train list.
Return	Enumeration

SIGLENT

Default	SINGLE
Menu	PULSE > Pulse Mode
Example	PULM:MODE DOUB

3.5.8.6 Pulse Period ([:SOURce]:PULM:PERiod)

Command	[:SOURce]:PULM:PERiod <value>
Format	[:SOURce]:PULM:PERiod?
Instruction	Set the period of the generated pulse. The period determines the repetition frequency of the internal signal Get the period of the generated pulse
Parameter Type	Float, unit: ns, us, ms, s
Parameter Range	40 ns ~ 300 s
Return	Float, unit: s
Default	10 ms
Menu	PULSE > Pulse Period
Example	PULM:PER 220 us

3.5.8.7 Pulse Width ([:SOURce]:PULM:WIDTh)

Command	[:SOURce]:PULM:WIDTh <value>
Format	[:SOURce]:PULM:WIDTh?
Instruction	Set the width of the generated pulse Get the width of the generated pulse
Parameter Type	Float, unit: ns, us, ms, s
Parameter Range	20 ns ~ 300 s
Return	Float, unit: s
Default	2 ms
Menu	PULSE > Pulse Width
Example	PULM:WIDT 33 us

3.5.8.8 Double Pulse Delay ([:SOURce]:PULM:DOUBle:DELAy)

Command	[:SOURce]:PULM:DOUBle:DELAy <value>
Format	[:SOURce]:PULM:DOUBle:DELAy?
Instruction	Set the delay from the start of the first pulse to the start of the second pulse Get the delay from the start of the first pulse to the start of the second pulse
Parameter Type	Float, unit: ns, us, ms, s
Parameter Range	20 ns ~ 300 s
Return	Float, unit: s
Default	4 ms
Menu	PULSE > Double Pulse Delay
Example	:PULM:DOUBle:DELAy 2 ms

3.5.8.9 #2 Width ([:SOURce]:PULM:DOUBle:WIDTh)

Command	[:SOURce]:PULM:DOUBle:WIDTh <time>
Format	[:SOURce]:PULM:DOUBle:WIDTh?
Instruction	Set the width of the second pulse in the case of double pulse generation Get the width of the second pulse in the case of double pulse generation
Parameter Type	Float, unit: ns, us, ms, s
Parameter Range	20 ns ~ 300 s
Return	Float, unit: s
Default	2 ms
Menu	PULSE > #2 Width
Example	PULM:DOUBle:WIDTh 2 s

3.5.8.10 Pulse Train Add Row ([:SOURce]:PULM:TRAI:n:PAIR)

Command	[:SOURce]:PULM:TRAI:n:PAIR <row>
Format	
Instruction	Add default train pair value to the specified row
Parameter Type	Integer

SIGLENT

Parameter Range	1 ~ N
Return	None
Default	None
Menu	PULSE > Pulse Train > [+]
Example	PULM:TRAI:PAIR 1

3.5.8.11 Pulse Train Delete ([:SOURce]:PULM:TRAI:DELEte)

Command Format	[:SOURce]:PULM:TRAI:DELEte <row>
Instruction	Delete the train pair
Parameter Type	Integer
Parameter Range	Normal Mode: 1 ~ 2047 Advanced Mode: 1 ~ 900
Return	None
Default	None
Menu	PULSE > Pulse Train > [-]
Example	PULM:TRAI:DELEte 5

3.5.8.12 Pulse Train Edit On Time

([:SOURce]:PULM:TRAI:DATA:ONTIme)

Command Format	[:SOURce]:PULM:TRAI:DATA:ONTIme <raw>,<on_time>
Instruction	Edit train ontime value
Parameter Type	Integer, Float, unit: ns, us, ms, s
Parameter Range	Raw: 1 ~ count of pair. Normal Mode: 20ns ~ 300s Advanced Mode: 10us~300s
Return	None
Default	None
Menu	PULSE > Pulse Train
Example	:PULM:TRAI:DATA:ONTIme 1,10 ms

3.5.8.13 Pulse Train Edit Off Time

([:SOURce]:PULM:TRAI:DATA:OFFTime)

Command Format	[:SOURce]:PULM:TRAI:DATA:OFFTime <raw>,<off_time>
Instruction	Edit train off time value
Parameter Type	Integer, Float, unit: ns, us, ms, s
Parameter Range	Raw: 1 ~ count of pair. Normal Mode: 20ns ~ 300s Advanced Mode: 400us~300s
Return	None
Default	None
Menu	PULSE > Pulse Train
Example	:PULM:TRAI:DATA:OFFTime 1, 20 ms

3.5.8.14 Pulse Train Edit Freq ([:SOURce]:PULM:TRAI:DATA:FREQ)

Command Format	[:SOURce]:PULM:TRAI:DATA:FREQ <raw>,<freq>
Instruction	Edit train pair value
Parameter Type	Integer, Float, unit: Hz, kHz, MHz, GHz, Default "Hz"
Parameter Range	Raw: 1 ~ count of pair. Freq: 9kHz ~ Max Freq
Return	None
Default	None
Menu	PULSE > Pulse Train
Example	:PULM:TRAI:DATA:FREQ 1,100 MHz

3.5.8.15 Pulse Train Edit Power

([:SOURce]:PULM:TRAI:DATA:POWer)

Command Format	[:SOURce]:PULM:TRAI:DATA:POWer <raw>,<power >
Instruction	Edit train pair value

SIGLENT

Parameter Type	Integer, Float, unit: dBm Default: dBm
Parameter Range	Raw: 1 ~ count of pair. Power: Full level range.
Return	None
Default	None
Menu	PULSE > Pulse Train
Example	:PULM:TRAI:DATA:POWer 1,-20 dBm

3.5.8.16 Pulse Train Edit Count

([:SOURce]:PULM:TRAI:DATA:COUNT)

Command Format	[:SOURce]:PULM:TRAI:DATA:COUNT <raw>,<count>
Instruction	Edit train pair value
Parameter Type	Integer, Integer
Parameter Range	Raw: 1 ~ count of pair. Count: 1 ~ 65535
Return	None
Default	None
Menu	PULSE > Pulse Train
Example	[:SOURce]:PULM:TRAI:DATA:COUNT 1,3

3.5.8.17 Pulse Advanced Mode State

([:SOURce]:PULM:TRAI:ADVance)

Command Format	[:SOURce]:PULM:TRAI:ADVance ON OFF 1 0 [:SOURce]:PULM:TRAI:ADVance?
Instruction	Activate/Deactivate the pulse advanced mode Get the state of pulse advanced mode
Parameter Type	Boolean
Parameter Range	ON OFF 1 0
Return	Boolean

Default	0
Menu	PULSE > Advanced Mode
Example	:PULM:TRAI:ADVANCE ON

3.5.8.18 List Pulse Train ([:SOURce]:PULM:TRAI:LIST?)

Command Format	[:SOURce]:PULM:TRAI:LIST? <begin_row>,<end_row>
Instruction	View starting row to end row data
Parameter Type	Integer, Integer
Parameter Range	Begin_row: 1 ~ the count of the pulse list End_row: Begin_row ~ the count of the pulse list
Return	String
Default	None
Menu	PULSE > Pulse Train
Example	:PULM:TRAI:LIST? 1,3

3.5.8.19 Pulse Train Count ([:SOURce]:PULM:TRAI:COUNT?)

Command Format	[:SOURce]:PULM:TRAI:COUNT?
Instruction	Get count of train list
Parameter Type	None
Parameter Range	None
Return	Integer
Default	1
Menu	PULSE > Pulse Train
Example	:PULM:TRAI:COUNT?

3.5.8.20 Pulse Train Clear ([:SOURce]:PULM:TRAI:CLEAr)

Command Format	[:SOURce]:PULM:TRAI:CLEAr
Instruction	Clear train pair list

SIGLENT

Parameter Type	None
Parameter Range	None
Return	None
Default	None
Menu	PULSE > Pulse Train > Store
Example	PULM:TRAI:n:CLEAr

3.5.8.21 Pulse Train Load ([:SOURce]:PULM:TRAI:n:LOAD)

Command Format	[:SOURce]:PULM:TRAI:n:LOAD <file>
Instruction	Load train pair list
Parameter Type	String
Parameter Range	None
Return	None
Default	None
Menu	PULSE > Pulse Train > Load
Example	PULM:TRAI:n:LOAD "U-disk3/test.pulstrn" PULM:TRAI:n:LOAD "Local/test.pulstrn"

3.5.8.22 Pulse Train Store ([:SOURce]:PULM:TRAI:n:STORE)

Command Format	[:SOURce]:PULM:TRAI:n:STORE <file>
Instruction	Store train pair list
Parameter Type	String
Parameter Range	None
Return	None
Default	None
Menu	PULSE > Pulse Train
Example	PULM:TRAI:n:STORE "U-disk3/test.pulstrn"

	PULM:TRAI:STORE "Local /test.pulstrn"
--	---------------------------------------

3.5.8.23 Trigger Out ([:SOURce]:PULM:TRIGger:STATe)

Command	[:SOURce]:PULM:TRIGger:STATe ON OFF 1 0
Format	[:SOURce]:PULM:TRIGger:STATe?
Instruction	Set the trigger output status Get the trigger output status
Parameter Type	Boolean
Parameter Range	ON OFF 1 0
Return	Boolean
Default	1
Menu	PULSE > Trigger Out
Example	PULM:TRIGger:STATe ON

3.5.8.24 Pulse Trigger ([:SOURce]:PULM:TRIGger:MODE)

Command	[:SOURce]:PULM:TRIGger:MODE AUTO KEY EXTernal EGATe
Format	[:SOURce]:PULM:TRIGger:MODE?
Instruction	Select the trigger mode for pulse modulation Get the trigger mode for pulse modulation
Parameter Type	Enumeration
Parameter Range	AUTO KEY EXTernal EGATe
Return	Enumeration
Default	AUTO
Menu	PULSE > Pulse Trigger
Example	PULM:TRIG:MODE EXTernal

3.5.8.25 Trig Polarity

([:SOURce]:PULM:TRIGger:EXTernal:GATE:POLarity)

Command	[:SOURce]:PULM:TRIGger:EXTernal:GATE:POLarity NORMal INVerted
---------	---

SIGLENT

Format	[[:SOURce]:PULM:TRIGger:EXTernal:GATE:POLarity?
Instruction	Select the polarity of the gate signal Get the polarity of the gate signal
Parameter Type	Enumeration
Parameter Range	NORMal INVerted
Return	Enumeration
Default	NORMal
Menu	PULSE > Pulse Polarity
Example	PULM:TRIG:EXT:GATE:POL NORMal

3.5.8.26 Trig Delay ([[:SOURce]:PULM:DELay])

Command	[[:SOURce]:PULM:DELay <value>
Format	[[:SOURce]:PULM:DELay?
Instruction	Set the pulse delay Get the pulse delay
Parameter Type	Float, unit: ns, us, ms, s
Parameter Range	140 ns ~ 300 s
Return	Float, unit: s
Default	140 ns
Menu	PULSE > Trig Delay
Example	PULM:DEL 30 ms

3.5.8.27 Trig Slope ([[:SOURce]:PULM:TRIGger:EXTernal:SLOPe])

Command	[[:SOURce]:PULM:TRIGger:EXTernal:SLOPe NEGative POSitive
Format	[[:SOURce]:PULM:TRIGger:EXTernal:SLOPe?
Instruction	Set the polarity of the active slope of an applied trigger at the PULSE EXT connector Get the polarity of the active slope of an applied trigger at the PULSE EXT connector
Parameter Type	Enumeration

Parameter Range	NEGative POSitive
Return	Enumeration
Default	POSitive
Menu	PULSE > Trig Slope
Example	PULM:TRIG:EXT:SLOP NEG

3.5.9 [:SOURce]:LFOutput Subsystem

3.5.9.1 LF State ([:SOURce]:LFOutput[:STATe])

Command	[:SOURce]:LFOutput ON OFF 1 0
Format	[:SOURce]:LFOutput?
Instruction	Activate/deactivate the LF output Get the LF output state
Parameter Type	Boolean
Parameter Range	ON OFF 1 0
Return	Boolean
Default	0
Menu	LF > LF State
Example	LFOutput ON

3.5.9.2 LF Level ([:SOURce]:LFOutput:VOLTage)

Command	[:SOURce]:LFOutput:VOLTage <volt>
Format	[:SOURce]:LFOutput:VOLTage?
Instruction	Set the voltage of the LF output signal Get the voltage of the LF output signal
Parameter Type	Float, unit: dBm, dBmV, dBuV, V, W, Default: V (Here V is the peak-to-peak value)
Parameter Range	1 mVpp ~ 3 Vpp
Return	Float, unit: Vpp
Default	0.5 Vpp

SIGLENT

Menu	LF > LF Voltage
Example	LFOutput:VOLTage 2 V

3.5.9.3 LF Offset ([:SOURce]:LFOutput:OFFSEt)

Command	[:SOURce]:LFOutput:OFFSEt <volt>
Format	[:SOURce]:LFOutput:OFFSEt?
Instruction	Set the voltage offset of the LF output signal Get the voltage offset of the LF output signal
Parameter Type	Float, unit: dBm, dBmV, dBuV, V, W, Default: V
Parameter Range	$ LFOffset \leq \max(2.5V - \frac{1}{2} LEVEL, 2V)$
Return	Float, unit: V
Default	0 V
Menu	LF > LF Offset
Example	LFOutput:OFFSEt 1 V

3.5.9.4 LF Frequency ([:SOURce]:LFOutput:FREQuency)

Command	[:SOURce]:LFOutput:FREQuency <freq>
Format	[:SOURce]:LFOutput:FREQuency?
Instruction	Set LF out put frequency. Get LF out put frequency If the signal source is set to "Internal", the instrument performs the analog modulations (AM/FM /PM) with this frequency.
Parameter Type	Float, unit: Hz, kHz, MHz, GHz, Default "Hz"
Parameter Range	0.01 Hz ~ 1 MHz
Return	Float, unit: Hz
Default	1 kHz
Menu	LF > LF Frequency
Example	LFOutput:FREQuency 10 kHz

3.5.9.5 LF Shape ([:SOURce]:LFOutput:SHAPE)

Command	[:SOURce]:LFOutput:SHAPE SINE SQUare TRIangle SAWTooth DC
Format	[:SOURce]:LFOutput:SHAPE?
Instruction	Select the shape of the LF signal Get the shape of the LF signal
Parameter Type	Enumeration
Parameter Range	SINE SQUare TRIangle SAWTooth DC
Return	Enumeration
Default	SINE
Menu	LF > LF Shape
Example	LFOutput:SHAPE TRIangle

3.5.9.6 LF Phase ([:SOURce]:LFOutput:PHASE)

Command	[:SOURce]:LFOutput:PHASE <deg>
Format	[:SOURce]:LFOutput:PHASE?
Instruction	Set the phase of the LF output signal Get the phase of the LF output signal
Parameter Type	Float, unit: deg
Parameter Range	-360 deg ~ 360 deg
Return	Float, unit: deg
Default	0 deg
Menu	LF > LF Phase
Example	LFOutput:PHASE 20

3.5.10 [:SOURce]:LFOutput:SWEep Subsystem

3.5.10.1 Sweep State ([:SOURce]:LFOutput:SWEep)

Command	[:SOURce]:LFOutput:SWEep ON OFF 0 1
Format	[:SOURce]:LFOutput:SWEep?

SIGLENT

Instruction	Activate/Deactivate the LF frequency sweep signal generation Get the state of LF frequency sweep
Parameter Type	Boolean
Parameter Range	ON OFF 0 1
Return	Boolean
Default	0
Menu	LF Sweep > LF State
Example	:LFOutput:SWEep 1

3.5.10.2 Sweep Direction ([:SOURce]:LFOutput:SWEep:DIRect)

Command	[:SOURce]:LFOutput:SWEep:DIRect UP DOWN
Format	[:SOURce]:LFOutput:SWEep:DIRect?
Instruction	Set the sweep direction Get the sweep direction
Parameter Type	Enumeration
Parameter Range	UP DOWN
Return	Enumeration
Default	UP
Menu	LF Sweep > Sweep Direction
Example	:LFOutput:SWEep:DIRect DOWN

3.5.10.3 Start Freq

([:SOURce]:LFOutput:SWEep:START:FREQuency)

Command	[:SOURce]:LFOutput:SWEep:START:FREQuency <freq>
Format	[:SOURce]:LFOutput:SWEep:START:FREQuency?
Instruction	Set the start frequency of sweep mode Get the start frequency of sweep mode
Parameter Type	Float, unit: Hz, kHz, MHz, GHz, Default "Hz"
Parameter	0.01 Hz ~ Stop frequency

Range	
Return	Float, unit: Hz
Default	500 Hz
Menu	LF Sweep > Start Freq
Example	:LFOutput:SWEep:STARt:FREQuency 100

3.5.10.4 Stop Freq ([:SOURce]:LFOutput:SWEep:STOP:FREQuency)

Command	[:SOURce]:LFOutput:SWEep:STOP:FREQuency <freq>
Format	[:SOURce]:LFOutput:SWEep:STOP:FREQuency?
Instruction	Set the stop frequency of sweep mode Get the stop frequency of sweep mode
Parameter Type	Float, unit: Hz, kHz, MHz, GHz, Default "Hz"
Parameter Range	Start frequency ~ Maximum frequency of LF
Return	Float, unit: Hz
Default	1.5 kHz
Menu	LF Sweep > Stop Freq
Example	:LFOutput:SWEep:STOP:FREQuency 1000

3.5.10.5 Center Freq

([:SOURce]:LFOutput:SWEep:CENTer:FREQuency)

Command	[:SOURce]:LFOutput:SWEep:CENTer:FREQuency <freq>
Format	[:SOURce]:LFOutput:SWEep:CENTer:FREQuency?
Instruction	Set the center frequency of sweep mode Get the center frequency of sweep mode
Parameter Type	Float, unit: Hz, kHz, MHz, GHz, Default "Hz"
Parameter Range	0.01 Hz ~ Maximum frequency of LF
Return	Float, unit: Hz
Default	1 kHz
Menu	LF Sweep > Center Freq
Example	:LFOutput:SWEep:CENTer:FREQuency 550

3.5.10.6 Freq Span

([:SOURce]:LFOutput:SWEep:SPAN:FREQuency)

Command	[:SOURce]:LFOutput:SWEep:SPAN:FREQuency <freq>
Format	[:SOURce]:LFOutput:SWEep:SPAN:FREQuency?
Instruction	Set the center frequency of sweep mode Get the center frequency of sweep mode
Parameter Type	Float, unit: Hz, kHz, MHz, GHz, Default "Hz"
Parameter Range	0 Hz ~ Maximum frequency of LF – 0.01 Hz
Return	Float, unit: Hz
Default	1 kHz
Menu	LF Sweep > Freq Span
Example	:LFOutput:SWEep:SPAN:FREQuency 550

3.5.10.7 Sweep Time ([:SOURce]:LFOutput:SWEep:DWELI)

Command	[:SOURce]:LFOutput:SWEep:DWELI <time>
Format	[:SOURce]:LFOutput:SWEep:DWELI?
Instruction	Set the sweep time of sweep mode Get the sweep time of sweep mode
Parameter Type	Float, unit: ns, us, ms, s
Parameter Range	1 ms ~ 500 s
Return	Float, unit: s
Default	1 s
Menu	LF Sweep > Sweep Time
Example	:LFOutput:SWEep:DWELI 2 s

3.5.10.8 Trigger Mode ([:SOURce]:LFOutput:SWEep:TRIGger:TYPE)

Command	[:SOURce]:LFOutput:SWEep:TRIGger:TYPE AUTO KEY BUS EXT
Format	[:SOURce]:LFOutput:SWEep:TRIGger:TYPE?
Instruction	Select the LF frequency sweep trigger mode

	Get the LF frequency sweep trigger mode
Parameter Type	Enumeration
Parameter Range	AUTO KEY BUS EXT
Return	Enumeration
Default	AUTO
Menu	LF Sweep > Trigger Mode
Example	:LFOutput:SWEep:TRIGger:TYPE KEY

3.5.10.9 Sweep Shape ([:SOURce]:LFOutput:SWEep:SHAPE)

Command	[:SOURce]:LFOutput:SWEep:SHAPE TRlangle SAWTooth
Format	[:SOURce]:LFOutput:SWEep:SHAPE?
Instruction	Select the waveform shape of the sweep signal Get the waveform shape of the sweep signal
Parameter Type	Enumeration
Parameter Range	TRlangle SAWTooth
Return	Enumeration
Default	SAWTooth
Menu	LF Sweep > Sweep Shape
Example	:LFOutput:SWEep:SHAPE TRlangle

3.5.10.10 Sweep Space ([:SOURce]:LFOutput:SWEep:SPACing)

Command	[:SOURce]:LFOutput:SWEep:SPACing LINear LOGarithmic
Format	[:SOURce]:LFOutput:SWEep:SPACing?
Instruction	Select the mode for the calculation of the frequency sweep intervals Get the mode for the calculation of the frequency sweep intervals
Parameter Type	Enumeration
Parameter Range	LINear LOGarithmic
Return	Enumeration
Default	LINear

SIGLENT

Menu	LF Sweep > Sweep Space
Example	:LFOutput:SWEep:SPACing LOGarithmic

3.6 Sense Subsystem

3.6.1 Sensor Info (:SENSe[:POWer]:TYPE)

Command Format	:SENSe[:POWer]:TYPE?
Instruction	Query the type of sensor connected to the POWER SENSOR connector
Parameter Type	None
Parameter Range	None
Return	String
Default	None
Menu	SENSOR > Sensor Info
Example	SENSe:TYPE?

3.6.2 Sensor State (:SENSe[:POWer]:STATus)

Command Format	:SENSe[:POWer]:STATus OFF ON 0 1 :SENSe[:POWer]:STATus?
Instruction	Set the sensor state Get the sensor state
Parameter Type	Boolean
Parameter Range	OFF ON 0 1
Return	Boolean
Default	0
Menu	SENSOR > Sensor State
Example	SENSe:STATus ON

3.6.3 Measurement (:SENSe[:POWer]:VALue)

Command	:SENSe[:POWer]:VALue?
---------	-----------------------

Format	
Instruction	Indicate the current reading of the sensor
Parameter Type	None
Parameter Range	None
Return	Float, unit: dBm
Default	None
Menu	SENSOR > Measurement
Example	SENSe:VALue?

3.6.4 Statistics State

(:SENSe[:POWer]:STATIStics:STATe)

Command	:SENSe[:POWer]:STATIStics:STATe ON OFF 1 0
Format	:SENSe[:POWer]:STATIStics:STATe?
Instruction	Set statistics state Get statistics state
Parameter Type	Boolean
Parameter Range	ON OFF 1 0
Return	Boolean
Default	0
Menu	SENSOR > Statistics
Example	SENSe:STATIStics:STATe ON

3.6.5 Statistics Value (:READ[:POWer])

Command	:READ[:POWer]?
Format	
Instruction	Indicate the measured mean value and maximum value
Parameter Type	None
Parameter Range	None
Return	String

SIGLENT

Default	None
Menu	SENSOR > Statistics
Example	READ?

3.6.6 Statistics Max Value

(:SENSe[:POWer]:STATIStics:MAX?)

Command Format	:SENSe[:POWer]:STATIStics:MAX?
Instruction	Indicate the measured maximum value
Parameter Type	None
Parameter Range	None
Return	Float, unit: dBm
Default	None
Menu	SENSOR > Statistics
Example	SENSe:STATIStics:MAX?

3.6.7 Statistics Min Value

(:SENSe[:POWer]:STATIStics:MIN?)

Command Format	:SENSe[:POWer]:STATIStics:MIN?
Instruction	Indicate the measured minimum value
Parameter Type	None
Parameter Range	None
Return	Float, unit: dBm
Default	None
Menu	SENSOR > Statistics
Example	SENSe:STATIStics:MIN?

3.6.8 Statistics Mean Value

(:SENSe[:POWer]:STATIStics:AVG?)

Command Format	:SENSe[:POWer]:STATIStics:AVG?
Instruction	Indicate the measured mean value
Parameter Type	None
Parameter Range	None
Return	Float, unit: dBm
Default	None
Menu	SENSOR > Statistics
Example	SENSe:STATIStics:AVG?

3.6.9 Statistics Count

(:SENSe[:POWer]:STATIStics:COUNT?)

Command Format	:SENSe[:POWer]:STATIStics:COUNT?
Instruction	Indicate the number of measurements being used to calculate the statistics
Parameter Type	None
Parameter Range	None
Return	Integer
Default	None
Menu	SENSOR > Statistics
Example	SENSe:STATIStics:COUNT?

3.6.10 Statistics Clear

(:SENSe[:POWer]:STATIStics:CLEAR)

Command Format	:SENSe[:POWer]:STATIStics:CLEAR
Instruction	Clear the statistics counter

SIGLENT

Parameter Type	None
Parameter Range	None
Return	None
Default	None
Menu	SENSOR > Statistics
Example	SENSe:STATIStics:CLEAr

3.6.11 Auto Zero (:CALibration:ZERO:TYPE)

Command	:CALibration:ZERO:TYPE INTernal EXTernal
Format	:CALibration:ZERO:TYPE?
Instruction	Select zero type Get zero type
Parameter Type	Enumeration
Parameter Range	INTernal EXTernal
Return	Enumeration
Default	INTernal
Menu	SENSOR > Auto Zero
Example	CALibration:ZERO:TYPE EXTernal

3.6.12 Zeroing (:SENSe[:POWer]:ZERO)

Command	:SENSe[:POWer]:ZERO
Format	
Instruction	Perform zeroing of the sensor
Parameter Type	None
Parameter Range	None
Return	None
Default	None
Menu	SENSOR > Click to perform zeroing
Example	:SENSe:ZERO

3.6.13 Frequency Type (:SENSe[:POWer]:SOURce)

Command	:SENSe[:POWer]:SOURce RF USER
Format	:SENSe[:POWer]:SOURce?
Instruction	Select the signal source for the measurement Get the signal source for the measurement
Parameter Type	Enumeration
Parameter Range	RF USER
Return	Enumeration
Default	RF
Menu	SENSOR > Frequency
Example	SENSe:SOURce RF

3.6.14 Frequency (:SENSe[:POWer]:FREQuency)

Command	:SENSe[:POWer]:FREQuency <type>
Format	:SENSe[:POWer]:FREQuency?
Instruction	Set the frequency for frequency type " USER" Get the frequency for frequency type " USER"
Parameter Type	Float, unit: Hz, kHz, MHz, GHz, Default "Hz"
Parameter Range	9 kHz ~ 3.2 GHz
Return	Float, unit: Hz
Default	None
Menu	SENSOR > Frequency
Example	SENSe:FREQuency 1 MHz

3.6.15 Level Offset State

(:SENSe[:POWer]:OFFSet:STATe)

Command	:SENSe[:POWer]:OFFSet:STATe ON OFF 0 1
Format	:SENSe[:POWer]:OFFSet:STATe?
Instruction	Switch the power offset switch status Get the power offset switch status

SIGLENT

Parameter Type	Boolean
Parameter Range	ON OFF 0 1
Return	Boolean
Default	0
Menu	SENSOR > Level Offset
Example	SENSE:OFFSet:STATe ON

3.6.16 Level Offset (:SENSE[:POWER]:OFFSet)

Command	:SENSE[:POWER]:OFFSet <power>
Format	:SENSE[:POWER]:OFFSet?
Instruction	The command enters a level offset which is mathematically added to the measured level value Get the level offset which is mathematically added to the measured level value
Parameter Type	Float
Parameter Range	Limit by power sensor.
Return	Float, unit: dB
Default	0 dB
Menu	SENSOR > Level Offset
Example	SENSE:OFFSet 10

3.6.17 Average Type (:SENSE[:POWER]:FILTER:TYPE)

Command	:SENSE[:POWER]:FILTER:TYPE AUTO USER NSRatio
Format	:SENSE[:POWER]:FILTER:TYPE?
Instruction	Select the averaging mode Get the averaging mode
Parameter Type	Enumeration
Parameter Range	AUTO USER NSRatio
Return	Enumeration
Default	None

Menu	SENSOR > Averaging
Example	SENSE:FILTer:TYPE AUTO

3.6.18 Average Times (:SENSe[:POWer]:FILTer:LENGth)

Command	:SENSe[:POWer]:FILTer:LENGth <length>
Format	:SENSe[:POWer]:FILTer:LENGth?
Instruction	Set the average number times
Parameter Type	Integer
Parameter Range	Limit by power sensor
Return	Float
Default	None
Menu	SENSOR > Averaging
Example	SENSE:FILTer:LENGth 10

3.6.19 Internal Noise (:SENSe[:POWer]:FILTer:NSRatio)

Command	:SENSe[:POWer]:FILTer:NSRatio <noise>
Format	:SENSe[:POWer]:FILTer:NSRatio?
Instruction	The power sensor will control the internal noise that does not exceed the set value of the fixed noise parameter
Parameter Type	Float, unit: dB
Parameter Range	Limit by power sensor.
Return	Float, unit: dB
Default	None
Menu	SENSOR > Averaging
Example	SENSE:FILTer:NSRatio 1

3.6.20 Logging (:SENSe[:POWer]:LOGGing:STATe)

Command	:SENSe[:POWer]:LOGGing:STATe <state>
Format	:SENSe[:POWer]:LOGGing:STATe?
Instruction	Set logging state Get logging state

SIGLENT

Parameter Type	Boolean
Parameter Range	ON OFF 1 0
Return	Boolean
Default	0
Menu	SENSOR > Logging
Example	SENSe:LOGGing:STATe ON

3.7 I/Q Subsystem

3.7.1[:SOURce]:FUNCTion Subsystem

3.7.1.1 I/Q Mod Function Switch

Command	[:SOURce]:FUNCTion:DM:STATe ON OFF 1 0
Format	[:SOURce]:FUNCTion:DM:STATe?
Instruction	This command configure the function switch of I/Q MOD
Parameter Type	Boolean
Parameter Range	ON OFF 1 0
Return	Boolean
Default	0
Menu	HOME > I/Q MOD > on
Example	:FUNCTion:DM:STATe ON

3.7.2[:SOURce]:RADio:CUSTom Subsystem

3.7.2.1 Custom State ([:SOURce]:RADio:CUSTom[:STATe])

Command	[:SOURce]:RADio:CUSTom[:STATe] ON OFF 1 0
Format	[:SOURce]:RADio:CUSTom[:STATe]?

Instruction	This command enables or disables the Custom modulation
Parameter Type	Boolean
Parameter Range	ON OFF 1 0
Return	Boolean
Default	0
Menu	Custom > Custom State
Example	:RADio:CUSTom 1

3.7.2.2 Data Setup ([:SOURce]:RADio:CUSTom:DATA)

Command Format	[:SOURce]:RADio:CUSTom:DATA PN7 PN9 PN15 PN23 USER [:SOURce]:RADio:CUSTom:DATA?
Instruction	This command sets the data pattern for unframed transmission
Parameter Type	Enumeration
Parameter Range	PN7 PN9 PN15 PN23 USER
Return	Enumeration
Default	PN7
Menu	Custom > Data Source > Data Setup
Example	:RADio:CUSTom:DATA PN9

3.7.2.3 Symbol Rate ([:SOURce]:RADio:CUSTom:SRATe)

Command Format	[:SOURce]:RADio:CUSTom:SRATe <val> [:SOURce]:RADio:CUSTom:SRATe?
Instruction	This command sets the transmission symbol rate. Symbol rate is the bit rate divided by the bits per symbol. A change in the symbol rate affects the bit rate
Parameter Type	Float
Parameter Range	500 Sps ~ 120 MSps
Return	Float
Default	1 MSps
Menu	Custom > Data Source > Symbol Rate

SIGLENT

Example	:RADio:CUSTom:SRATe 2000000
---------	-----------------------------

3.7.2.4 Symbol Length ([:SOURce]:RADio:CUSTom:SLENgth)

Command	[:SOURce]:RADio:CUSTom:SLENgth <val>
Format	[:SOURce]:RADio:CUSTom:SLENgth?
Instruction	This command sets the transmission symbol length
Parameter Type	Integer
Parameter Range	100 ~ 100000
Return	Integer
Default	512
Menu	Custom > Data Source > Symbol Length
Example	:RADio:CUSTom:SLENgth 1024

3.7.2.5 Bits/Symbol ([:SOURce]:RADio:CUSTom:SBIT?)

Command	[:SOURce]:RADio:CUSTom:SBIT?
Format	[:SOURce]:RADio:CUSTom:SBIT?
Instruction	This command gets the bits per symbol. This value is determined by the modulation type
Parameter Type	None
Parameter Range	1 ~ 10
Return	Integer
Default	4
Menu	Custom > Data Source > Bits/Symbol
Example	:RADio:CUSTom:SBIT?

3.7.2.6 Mod Type ([:SOURce]:RADio:CUSTom:MODulation[:TYPE])

Command	[:SOURce]:RADio:CUSTom:MODulation[:TYPE]
Format	2ASK 4ASK 8ASK 16ASK BPSK QPSK 8PSK 16PSK DBPSK DQPSK D8PSK D16PSK HDQPSK HD8PSK OQPSK 8QAM 16QAM 32QAM 64QAM 128QAM 256QAM 512QAM 2FSK 4FSK 8FSK 16FSK MFSK USER

	<code>[[:SOURce]:RADio:CUSTom:MODulation[:TYPE]?</code>
Instruction	This command sets the modulation type for the custom personality
Parameter Type	Enumeration
Parameter Range	2ASK 4ASK 8ASK 16ASK BPSK QPSK 8PSK 16PSK DBPSK DQPSK D8PSK D16PSK HDQPSK HD8PSK OQPSK 8QAM 16QAM 32QAM:64QAM 128QAM 256QAM 512QAM 2FSK 4FSK 8FSK 16FSK MFSK USER
Return	Enumeration
Default	16QAM
Menu	Custom > Modulation > Mod Type
Example	<code>:RADio:CUSTom:MODulation 2ASK</code>

3.7.2.7 Gray (`[[:SOURce]:RADio:CUSTom:MODulation:GRAY]`)

Command Format	<code>[[:SOURce]:RADio:CUSTom:MODulation:GRAY ON OFF 1 0</code>
Format	<code>[[:SOURce]:RADio:CUSTom:MODulation:GRAY?</code>
Instruction	This command sets the modulation symbol to use gray code coding
Parameter Type	Boolean
Parameter Range	ON OFF 1 0
Return	Boolean
Default	0
Menu	Custom > Modulation > Gray
Example	<code>:RADio:CUSTom:MODulation:GRAY 1</code>

3.7.2.8 User Map Store

(`[[:SOURce]:RADio:CUSTom:MODulation:STORE]`)

Command Format	<code>[[:SOURce]:RADio:CUSTom:MODulation:STORE "<file name>"</code>
Instruction	This command saves the I/Q map to a user-defined I/Q file
Parameter Type	String
Parameter Range	None

SIGLENT

Return	None
Default	None
Menu	Custom > Modulation > Custom > Load
Example	:RADio:CUSTom:MODulation:STORe "test.map"

3.7.2.9 User Map Load

([:SOURce]:RADio:CUSTom:MODulation:UIQ)

Command Format	[:SOURce]:RADio:CUSTom:MODulation:UIQ "<file name>"
Instruction	This command selects a user-defined I/Q file from the signal generator flash
Parameter Type	String
Parameter Range	None
Return	None
Default	None
Menu	Custom > Modulation > Custom > Load
Example	:RADio:CUSTom:MODulation:UIQ "test.map"

3.7.2.10 User Map Get

([:SOURce]:RADio:CUSTom:MODulation:UIQ?)

Command Format	[:SOURce]:RADio:CUSTom:MODulation:UIQ?
Instruction	This command gets the user map list
Parameter Type	None
Parameter Range	None
Return	String
Default	0.500000 0.000000 1.000000 0.000000
Menu	Custom > Modulation > Custom
Example	:RADio:CUSTom:MODulation:UIQ?

3.7.2.11 User Map Add

([:SOURce]:RADio:CUSTom:MODulation:INSErt)

Command Format	[:SOURce]:RADio:CUSTom:MODulation:INSErt <pos>,<i data>,<q data>
Instruction	This command inserts the user map value
Parameter Type	Integer, Float, Float
Parameter Range	0 ~ size of user map, -1 ~ 1, -1 ~ 1
Return	None
Default	None
Menu	Custom > Modulation > Add
Example	:RADio:CUSTom:MODulation:INSErt 0,0.5,0.5

3.7.2.12 User Map Edit

([:SOURce]:RADio:CUSTom:MODulation:CHANGe)

Command Format	[:SOURce]:RADio:CUSTom:MODulation:CHANGe <pos>,<i data>,<q data>
Instruction	This command edits the user map value
Parameter Type	Integer, Float, Float
Parameter Range	0 ~ size of user map - 1, -1 ~ 1, -1 ~ 1
Return	None
Default	None
Menu	Custom > Modulation > Edit
Example	:RADio:CUSTom:MODulation:CHANGe 0,0.5,0.5

3.7.2.13 User Map Delete

([:SOURce]:RADio:CUSTom:MODulation:DELEte)

Command Format	[:SOURce]:RADio:CUSTom:MODulation:DELEte <pos>
Instruction	This command deletes the user map value

SIGLENT

Parameter Type	Integer
Parameter Range	0 ~ size of user map - 1
Return	None
Default	None
Menu	Custom > Modulation > Delete
Example	:RADio:CUSTom:MODulation:DELEte 0

3.7.2.14 User Map Clear

([:SOURce]:RADio:CUSTom:MODulation:CLEAr)

Command Format	[:SOURce]:RADio:CUSTom:MODulation:CLEAr
Instruction	This command clears the user map value
Parameter Type	None
Parameter Range	None
Return	None
Default	None
Menu	Custom > Modulation > Clear
Example	:RADio:CUSTom:MODulation: CLEAR

3.7.2.15 FSK Deviation

([:SOURce]:RADio:CUSTom:MODulation:FSK[:DEViation])

Command Format	[:SOURce]:RADio:CUSTom:MODulation:FSK[:DEViation] <val> [:SOURce]:RADio:CUSTom:MODulation:FSK[:DEViation]?
Instruction	This command sets the symmetric FSK frequency deviation value
Parameter Type	Float, unit: Hz, kHz, MHz, GHz, Default "Hz"
Parameter Range	$-0.8 * \text{symbol rate} * \text{oversampling} \sim 0.8 * \text{symbol rate} * \text{oversampling}$
Return	Float, unit: Hz
Default	600000

Menu	Custom > Modulation > Clear
Example	:RADio:CUSTom:MODulation:FSK 0

3.7.2.16 Filter Type

([:SOURce] RADio:CUSTom:FILTer)

Command	[:SOURce]:RADio:CUSTom:FILTer <type>
Format	[:SOURce]:RADio:CUSTom:FILTer?
Instruction	This command specifies the Real-Time Modulation filter type
Parameter Type	Enumeration
Parameter Range	NONE RAISecosine ROOTcosine GAUSSian
Return	Enumeration
Default	ROOTcosine
Menu	Custom > Filter > Filter Type
Example	:RADio:CUSTom:FILTer GAUSSian

3.7.2.17 Filter Alpha ([:SOURce]:RADio:CUSTom:ALPHa)

Command	[:SOURce]:RADio:CUSTom:ALPHa <val>
Format	[:SOURce]:RADio:CUSTom:ALPHa?
Instruction	This command changes the Nyquist or root Nyquist filter's alpha value or Caussian's BT value
Parameter Type	Float
Parameter Range	0.010 ~ 1.000
Return	Float
Default	0.35
Menu	Custom > Filter > Filter Alpha
Example	:RADio:CUSTom:ALPHa 0.22

3.7.2.18 Filter Length ([:SOURce]:RADio:CUSTom:FILTer:LENGth)

Command	[:SOURce]:RADio:CUSTom:FILTer:LENGth <len>
---------	--

SIGLENT

Format	[[:SOURce]:RADio:CUSTom:FILTer:LENGth?
Instruction	This command changes the length of filter
Parameter Type	Integer
Parameter Range	1 ~ 512
Return	Integer
Default	128
Menu	Custom > Filter > Filter Length
Example	:RADio:CUSTom:FILTer:LENGth 64

3.7.2.19 OverSampling

([:SOURce]:RADio:CUSTom:FILTer:OVERsampling)

Command	[[:SOURce]:RADio:CUSTom:FILTer:OVERsampling <val>
Format	[[:SOURce]:RADio:CUSTom:FILTer:OVERsampling?
Instruction	This command changes the over-sample value of filter
Parameter Type	Integer
Parameter Range	2 ~ 32
Return	Integer
Default	2
Menu	Custom > Filter > OverSampling
Example	:RADio:CUSTom:FILTer:OVERsampling 4

3.7.2.20 Bit Rate ([:SOURce]:RADio:CUSTom:BRATe)

Command	[[:SOURce]:RADio:CUSTom:BRATe <rate>
Format	[[:SOURce]:RADio:CUSTom:BRATe?
Instruction	This command sets the bit rate in bits per second (bps–Mbps). The maximum bit rate is dependent on the modulation type and oversampling
Parameter Type	Float
Parameter Range	500/bit rate ~ 120 MHz/bit rate

Return	Float
Default	250 kHz
Menu	None
Example	:RADio:CUSTom:BRATe 1 MHz

3.7.2.21 Save Waveform ([:SOURce]:RADio:CUSTom:SAVE)

Command Format	[:SOURce]:RADio:CUSTom:SAVE "<file_name>"
Instruction	This command saves the Custom settings.
Parameter Type	String
Parameter Range	None
Return	None
Default	None
Menu	Custom > Save Waveform
Example	:RADio:CUSTom:SAVE "test.arb"

3.7.2.22 Update ([:SOURce]:RADio:CUSTom:DOWNload)

Command Format	[:SOURce]:RADio:CUSTom:DOWNload
Instruction	This command updates the Custom settings.
Parameter Type	String
Parameter Range	None
Return	None
Default	None
Menu	Custom > Update
Example	:RADio:CUSTom:DOWNload

3.7.3 [:SOURce]:RADio:MTONe Subsystem

3.7.3.1 Multitone State ([:SOURce]:RADio:MTONe:ARB[:STATe])

Command	[:SOURce]:RADio:MTONe:ARB[:STATe] ON OFF 1 0
Format	[:SOURce]:RADio:MTONe:ARB[:STATe]?
Instruction	This command enables or disables the multitone waveform generator function
Parameter Type	Boolean
Parameter Range	ON OFF 1 0
Return	Boolean
Default	0
Menu	Multitone > Multitone State
Example	:RADio:MTONe:ARB 1

3.7.3.2 Tone Number

([:SOURce]:RADio:MTONe:ARB:SETup:TABLE:NTONes)

Command	[:SOURce]:RADio:MTONe:ARB:SETup:TABLE:NTONes <num_tones>
Format	[:SOURce]:RADio:MTONe:ARB:SETup:TABLE:NTONes?
Instruction	This command defines the number of tones in the multitone waveform
Parameter Type	Integer
Parameter Range	1 ~ 20
Return	Integer
Default	2
Menu	Multitone > Tone Number
Example	:RADio:MTONe:ARB:SETup:TABLE:NTONes 1

3.7.3.3 Single Side

([:SOURce]:RADio:MTONe:ARB:SETup:TABLE:SINGLE)

Command	[:SOURce]:RADio:MTONe:ARB:SETup:TABLE:SINGLE ON OFF 1 0
Format	[:SOURce]:RADio:MTONe:ARB:SETup:TABLE:SINGLE?

Instruction	This command enables or disables the multitone single side
Parameter Type	Boolean
Parameter Range	ON OFF 1 0
Return	Boolean
Default	0
Menu	Multitone > Single Side
Example	:RADio:MTONe:ARB:SETup:TABLE:SINGle 1

3.7.3.4 Sample Rate ([:SOURce]:RADio:MTONe:ARB:SCLock:RATE)

Command	[:SOURce]:RADio:MTONe:ARB:SCLock:RATE <val>
Format	[:SOURce]:RADio:MTONe:ARB:SCLock:RATE?
Instruction	This command sets the sample clock rate for the Multitone modulation format
Parameter Type	Float, unit: Hz, kHz, MHz, GHz, Default "Hz"
Parameter Range	500 Hz ~ 240 MHz
Return	Float
Default	2 MHz
Menu	Multitone > Sample Rate
Example	:RADio:MTONe:ARB:SCLock:RATE 5000000

3.7.3.5 Freq Spacing

([:SOURce]:RADio:MTONe:ARB:SETup:TABLE:FSPacing)

Command	[:SOURce]:RADio:MTONe:ARB:SETup:TABLE:FSPacing <val>
Format	[:SOURce]:RADio:MTONe:ARB:SETup:TABLE:FSPacing?
Instruction	This command sets the frequency spacing between the total tones
Parameter Type	Float
Parameter Range	500 Hz ~ 120 MHz
Return	Float
Default	1 MHz

SIGLENT

Menu	Multitone > Sample Rate
Example	RADio:MTONe:ARB:SETup:TABLE:FSPacing 2000000

3.7.3.6 Save State ([:SOURce]:RADio:MTONe:ARB:SETup:STORE)

Command Format	[:SOURce]:RADio:MTONe:ARB:SETup:STORE "<file name>"
Instruction	This command stores the current multitone waveform setup in the signal generator file system of MTONE files
Parameter Type	String
Parameter Range	None
Return	None
Default	None
Menu	Multitone > Save State
Example	:RADio:MTONe:ARB:SETup:STORE "test.mulstate"

3.7.3.7 Load State ([:SOURce]:RADio:MTONe:ARB:SETup)

Command Format	[:SOURce]:RADio:MTONe:ARB:SETup "<file name>"
Instruction	This command retrieves a multitone waveform file
Parameter Type	String
Parameter Range	None
Return	None
Default	None
Menu	Multitone > Load State
Example	:RADio:MTONe:ARB:SETup "test.mulstate"

3.7.4 [:SOURce]:RADio:DMODulation Subsystem

3.7.4.1 Create and Load

([:SOURce]:RADio:DMODulation:ARB:SETup)

Command Format	[:SOURce]:RADio:DMODulation:ARB:SETup
Instruction	This command creates and loads a multi-carrier waveform
Parameter Type	None
Parameter Range	None
Return	None
Default	None
Menu	ARB > Multi Carrier > Create and Load
Example	:RADio:DMODulation:ARB:SETup

3.7.4.2 Multicarrier Assistant

([:SOURce]:RADio:DMODulation:ARB:SETup:MCARrier)

Command Format	[:SOURce]:RADio:DMODulation:ARB:SETup:MCARrier “<waveform>”,<num>,<freq_space> ”<file_name>” [:SOURce]:RADio:DMODulation:ARB:SETup:MCARrier?
Instruction	This command builds a table with the specified number of carriers and frequency spacing or retrieves the setup stored in the specified user file
Parameter Type	String, Integer, Double String
Parameter Range	waveform: None, num: 2 ~ 100, freq_space: 0 ~ (maximum sampling rate-waveform sampling rate)/(num-1), file_name: None
Return	String, Integer, Double
Default	*NONE,2,1000000
Menu	ARB > Multi Carrier > Carrier Table > Assistant
Example	:RADio:DMODulation:ARB:SETup:MCARrier SINE_WAVE,3,1000000

3.7.4.3 Carrier Table

([:SOURce]:RADio:DMODulation:ARB:SETup:MCARrier:TABLE)

Command	[:SOURce]:RADio:DMODulation:ARB:SETup:MCARrier:TABLE
Format	INIT APPend <carrier_num>,"<waveform>",<freq_offset>,<power>,<phase> [:SOURce]:RADio:DMODulation:ARB:SETup:MCARrier:TABLE? <pos>
Instruction	This command modifies the multicarrier table
Parameter Type	String, String, Double ,Double ,Double
Parameter Range	carrier_num: INIT APPend 1 ~ list rows, waveform: None, freq_offset: waveform sampling rate/4-maximum sampling rate/2 ~ maximum sampling rate/2- waveform sampling rate/4, power: -40 ~ 0, phase: -360 ~ 360, pos: 1 ~ list rows.
Return	String, Double, Double, Double, Double, Integer
Default	SINE_WAVE,0,0,0,2MHz,200
Menu	ARB > Multi Carrier > Carrier Table
Example	:RADio:DMODulation:ARB:SETup:MCARrier:TABLE INIT,SINE_WAVE,1000000,-10,20 :RADio:DMODulation:ARB:SETup:MCARrier:TABLE? 1

3.7.4.4 Carrier Save

([:SOURce]:RADio:DMODulation:ARB:SETup:MCARrier:STORE)

Command Format	[:SOURce]:RADio:DMODulation:ARB:SETup:MCARrier:STORE "<file_name>"
Instruction	This command stores the current multicarrier setup information
Parameter Type	String
Parameter Range	None
Return	None

Default	None
Menu	ARB > Multi Carrier > Carrier Table > Save
Example	:RADio:DMODulation:ARB:SETup:MCARrier:STORe "test.ml"

3.7.4.5 Waveform Name

([:SOURce]:RADio:DMODulation:ARB:SETup:MCARrier:NAME)

Command	[:SOURce]:RADio:DMODulation:ARB:SETup:MCARrier:NAME "<waveform>"
Format	[:SOURce]:RADio:DMODulation:ARB:SETup:MCARrier:NAME?
Instruction	This command sets the output waveform name
Parameter Type	String
Parameter Range	None
Return	String
Default	MULTICARRIER
Menu	ARB > Multi Carrier > Waveform Name
Example	:RADio:DMODulation:ARB:SETup:MCARrier:NAME "TEST"

3.7.5 [:SOURce]:RADio:ARB Subsystem

3.7.5.1 ARB State ([:SOURce]:RADio:ARB[:STATe])

Command	[:SOURce]:RADio:ARB[:STATe] ON OFF 1 0
Format	
Instruction	This command enables or disables the arbitrary waveform generator function
Parameter Type	Boolean
Parameter Range	ON OFF 1 0
Return	Boolean
Default	0
Menu	ARB > ARB State
Example	:RADio:ARB 1

3.7.5.2 Select Waveform ([:SOURce]:RADio:ARB:WAVeform)

Command	[:SOURce]:RADio:ARB:WAVeform "<WFM:file_name SEQ:file_name>"
Format	[:SOURce]:RADio:ARB:WAVeform?
Instruction	This command enables or disables the arbitrary waveform generator function
Parameter Type	String
Parameter Range	Existing segment or sequence
Return	String
Default	*NONE
Menu	ARB > Select Waveform > Select
Example	:RADio:ARB:WAVeform "WFM:SINE_WAVE"

3.7.5.3 Sample Clock ([:SOURce]:RADio:ARB:SCLock:RATE)

Command	[:SOURce]:RADio:ARB:SCLock:RATE <rate>
Format	[:SOURce]:RADio:ARB:SCLock:RATE?
Instruction	This command sets the sample clock rate for the dual ARB format
Parameter Type	Float, unit: Hz, kHz, MHz, GHz, Default "Hz"
Parameter Range	0.002 Hz ~ 240 MHz
Return	Float
Default	2 MHz
Menu	ARB > ARB Setup > Sample Clock
Example	:RADio:ARB:SCLock:RATE 4 MHz

3.7.5.4 Sequence ([:SOURce]:RADio:ARB:SEQuence)

Command	[:SOURce]:RADio:ARB:SEQuence
Format	"<file_name>",<waveform1>,<reps>,NONE M1 M2 M3 M4 M1M2 M1M3 M1M4 M2M3 M2M4 M3M4 M1M2M3 M1M2M4 M1M3M4 M2M3M4 ALL,{'<waveform2>",<reps>,NONE M1 M2 M3 M4 M1M2 M1M3 M1M4 M2M3 M2M4 M3M4 M1M2M3 M1M2M4 M1M3M4 M2M3M4 ALL}
	[:SOURce]:RADio:ARB:SEQuence? "<file_name>"

Instruction	This command creates a waveform sequence. A waveform sequence is made up of segments and other sequences. Any number of segments, up to a segment count limit of 1024, can be used to create a sequence. The count limit is determined by the number of segments in the waveform sequence. Repeated segments are included in the count limit.
Parameter Type	String, String, Integer, Enumeration
Parameter Range	None, None, 1 ~ 65536, NONE M1 M2 M3 M4 M1M2 M1M3 M1M4 M2M3 M2M4 M3M4 M1M2M3 M1M2M4 M1M3M4 M2M3M4 M1M2M3M4
Return	String
Default	None
Menu	ARB > Waveform Sequence > Build
Example	:RADio:ARB:SEQuence "TEST_SEQ","RENAME_WAVE",1,M1

3.7.5.5 Modulator Atten Type

([:SOURce]:RADio:ARB:IQ:MODulation:ATTen:AUTO)

Command	[:SOURce]:RADio:ARB:IQ:MODulation:ATTen:AUTO AUTO MANUal
Format	[:SOURce]:RADio:ARB:IQ:MODulation:ATTen:AUTO?
Instruction	This command enables or disables the I/Q attenuation auto mode
Parameter Type	Enumeration
Parameter Range	AUTO MANUal
Return	Enumeration
Default	AUTO
Menu	ARB > ARB Setup > Modulator Atten Type
Example	:RADio:ARB:IQ:MODulation:ATTen:AUTO AUTO

3.7.5.6 Modulation Atten

([:SOURce]:RADio:ARB:IQ:MODulation:ATTen)

Command	[:SOURce]:RADio:ARB:IQ:MODulation:ATTen <val>
Format	[:SOURce]:RADio:ARB:IQ:MODulation:ATTen?
Instruction	This command sets the attenuation level of the I/Q signals being modulated

SIGLENT

	through the signal generator RF path
Parameter Type	Float
Parameter Range	0 ~ 20
Return	Float
Default	6
Menu	ARB > ARB Setup > Modulation Atten
Example	:RADio:ARB:IQ:MODulation:ATTen 10

3.7.5.7 Real Time AWGN ([:SOURce]:RADio:ARB:NOISe[:STATe])

Command	[:SOURce]:RADio:ARB:NOISe[:STATe] ON OFF 1 0
Format	[:SOURce]:RADio:ARB:NOISe[:STATe]?
Instruction	This command enables or disables adding real-time additive white gaussian noise (AWGN) to the carrier modulated by the waveform being played by the dual ARB waveform player
Parameter Type	Boolean
Parameter Range	ON OFF 1 0
Return	Boolean
Default	0
Menu	ARB > ARB Setup > Real Time AWGN
Example	:RADio:ARB:NOISe 1

3.7.5.8 Output Mux ([:SOURce]:RADio:ARB:NOISe:OUTPut)

Command	[:SOURce]:RADio:ARB:NOISe:OUTPut CARRier NOISe CARRier_NOISe
Format	[:SOURce]:RADio:ARB:NOISe:OUTPut?
Instruction	This command selects output type of the Real Time AWGN.
Parameter Type	Enumeration
Parameter Range	CARRier NOISe CARRier_NOISe
Return	Enumeration
Default	CARRier_NOISe

Menu	ARB > ARB Setup > Real Time AWGN > Output Mux
Example	:RADio:ARB:NOISe:OUTPut CARRier

3.7.5.9 Power Control ([:SOURce]:RADio:ARB:NOISe:POWer:TYPE)

Command	[:SOURce]:RADio:ARB:NOISe:POWer:TYPE CARRier CHNO TONO TOPO
Format	[:SOURce]:RADio:ARB:NOISe:POWer:TYPE?
Instruction	This command selects the power control mode of the Real Time AWGN.
Parameter Type	Enumeration
Parameter Range	CARRier CHNO TONO TOPO
Return	Enumeration
Default	TOPO
Menu	ARB > ARB Setup > Real Time AWGN > Power Control Mode
Example	:RADio:ARB:NOISe:POWer:TYPE CARRier

3.7.5.10 Total Power ([:SOURce]:RADio:ARB:NOISe:POWer:TOTAL)

Command	[:SOURce]:RADio:ARB:NOISe:POWer:TOTAL <power>
Format	[:SOURce]:RADio:ARB:NOISe:POWer:TOTAL?
Instruction	This command sets the total power of the Real Time AWGN.
Parameter Type	Float
Parameter Range	-140 dBm ~ 10 dBm
Return	Float
Default	-120 dBm
Menu	ARB > ARB Setup > Real Time AWGN > Total Power
Example	:RADio:ARB:NOISe:POWer:TOTAL 0 dBm

3.7.5.11 Carrier Power

([:SOURce]:RADio:ARB:NOISe:POWer:CARRier)

Command	[:SOURce]:RADio:ARB:NOISe:POWer:CARRier <power>
Format	[:SOURce]:RADio:ARB:NOISe:POWer:CARRier?

SIGLENT

Instruction	This command sets the carrier power of the Real Time AWGN.
Parameter Type	Float
Parameter Range	According to the total power limit
Return	Float
Default	-123.27 dBm
Menu	ARB > ARB Setup > Real Time AWGN > Carrier Power
Example	:RADio:ARB:NOISe:POWer:CARRier 0 dBm

3.7.5.12 Channel Noise Power

([:SOURce]:RADio:ARB:NOISe:POWer:CHNOise)

Command	[:SOURce]:RADio:ARB:NOISe:POWer:CHNOise <power>
Format	[:SOURce]:RADio:ARB:NOISe:POWer:CHNOise?
Instruction	This command sets the channel noise power of the Real Time AWGN.
Parameter Type	Float
Parameter Range	According to the total power limit
Return	Float
Default	-123.27 dBm
Menu	ARB > ARB Setup > Real Time AWGN > Channel Power
Example	:RADio:ARB:NOISe:POWer:CHNOise 0 dBm

3.7.5.13 Total Noise Power ([:SOURce]:RADio:ARB:NOISe:POWer:TONoise)

Command	[:SOURce]:RADio:ARB:NOISe:POWer:TONoise <power>
Format	[:SOURce]:RADio:ARB:NOISe:POWer:TONoise?
Instruction	This command sets the total noise power of the Real Time AWGN.
Parameter Type	Float
Parameter Range	According to the total power limit
Return	Float

Default	-122.76 dBm
Menu	ARB > ARB Setup > Real Time AWGN > Noise Power
Example	:RADio:ARB:NOISe:POWer:TONoise 0 dBm

3.7.5.14 Carrier To Noise Ratio Format

([:SOURce]:RADio:ARB:NOISe:CN:FORMat)

Command	[:SOURce]:RADio:ARB:NOISe:CN:FORMat CARRier BIT
Format	[:SOURce]:RADio:ARB:NOISe:CN:FORMat?
Instruction	This command sets the carrier to noise ratio format of the Real Time AWGN.
Parameter Type	Enumeration
Parameter Range	CARRier BIT
Return	Enumeration
Default	CARRier
Menu	ARB > ARB Setup > Real Time AWGN > Carrier To Noise Ratio Format
Example	:RADio:ARB:NOISe:CN:FORMat BIT

3.7.5.15 Carrier To Noise Ratio ([:SOURce]:RADio:ARB:NOISe:CN)

Command	[:SOURce]:RADio:ARB:NOISe:CN <val>
Format	[:SOURce]:RADio:ARB:NOISe:CN?
Instruction	This command sets the carrier to noise ratio (C/N) in dB. The carrier power is defined as the total modulated signal power without noise power added. The noise power is applied over the specified bandwidth of the carrier signal.
Parameter Type	Float
Parameter Range	-100 dB ~ 100 dB
Return	Float
Default	0 dB
Menu	ARB > ARB Setup > Real Time AWGN > Carrier To Noise Ratio
Example	:RADio:ARB:NOISe:CN -5

3.7.5.16 Bit To Noise Ratio ([:SOURce]:RADio:ARB:NOISe:CBNO)

Command	[:SOURce]:RADio:ARB:NOISe:CBNO <val>
Format	[:SOURce]:RADio:ARB:NOISe:CBNO?
Instruction	This command sets the Eb/No (energy per bit over noise power density at the receiver or signal to noise ratio per bit)
Parameter Type	Float
Parameter Range	According to C/N and the carrier bit rate limit
Return	Float
Default	0 dB
Menu	ARB > ARB Setup > Real Time AWGN > Bit To Noise Ratio
Example	:RADio:ARB:NOISe:CBNO -5

3.7.5.17 Carrier Bit Rate ([:SOURce]:RADio:ARB:NOISe:BRATe)

Command	[:SOURce]:RADio:ARB:NOISe:BRATe <rate>
Format	[:SOURce]:RADio:ARB:NOISe:BRATe?
Instruction	This command sets the carrier bit rate of the Real Time AWGN.
Parameter Type	Float
Parameter Range	1 ~ 10*Carrier Bandwidth bps
Return	Float
Default	1 bps
Menu	ARB > ARB Setup > Real Time AWGN > Carrier Bit Rate
Example	:RADio:ARB:NOISe:BRATe 5

3.7.5.18 Carrier Bandwidth ([:SOURce]:RADio:ARB:NOISe:CBWidth)

Command	[:SOURce]:RADio:ARB:NOISe:CBWidth <bandwidth>
Format	[:SOURce]:RADio:ARB:NOISe:CBWidth?
Instruction	This command sets the carrier bandwidth over which the additive white gaussian noise (AWGN) is applied. The noise power will be integrated over the selected bandwidth for the purposes of calculating carrier to noise ratio (C/N)
Parameter	Float, unit: Hz, kHz, MHz, GHz, Default "Hz"

Type	
Parameter Range	1 Hz ~ 120 MHz
Return	Float, unit: Hz
Default	1 Hz
Menu	ARB > ARB Setup > Real Time AWGN > Carrier Bandwidth
Example	:RADio:ARB:NOISe:CBWidth 5000000

3.7.5.19 Flat Noise Bandwidth

([:SOURce]:RADio:ARB:NOISe:NBWidth)

Command	[:SOURce]:RADio:ARB:NOISe:NBWidth <bandwidth>
Format	[:SOURce]:RADio:ARB:NOISe:NBWidth?
Instruction	This command sets the flat noise bandwidth of the Real Time AWGN.
Parameter Type	Float, unit: Hz, kHz, MHz, GHz, Default "Hz"
Parameter Range	Carrier Bandwidth ~ 120 MHz
Return	Float, unit: Hz
Default	1 Hz
Menu	ARB > ARB Setup > Real Time AWGN > Flat Noise Bandwidth
Example	:RADio:ARB:NOISe:NBWidth 5000000

3.7.5.20 Baseband Offset ([:SOURce]:RADio:ARB:OFFSet:STATe)

Command	[:SOURce]:RADio:ARB:OFFSet:STATe ON OFF 1 0
Format	[:SOURce]:RADio:ARB:OFFSet:STATe?
Instruction	This command sets the state of baseband offset
Parameter Type	Boolean
Parameter Range	ON OFF 1 0
Return	Boolean
Default	0
Menu	ARB > ARB Setup > Baseband Offset
Example	:RADio:ARB:OFFSet:STATe 1

3.7.5.21 Offset Freq ([:SOURce]:RADio:ARB:OFFSet:FREQence)

Command	[:SOURce]:RADio:ARB:OFFSet:FREQence <freq>
Format	[:SOURce]:RADio:ARB:OFFSet:FREQence?
Instruction	This command sets the offset of frequency.
Parameter Type	Float, unit: Hz, kHz, MHz, GHz, Default "Hz"
Parameter Range	0 Hz ~ 60 MHz
Return	Float, unit: Hz
Default	0 Hz
Menu	ARB > ARB Setup > Baseband Offset
Example	:RADio:ARB:OFFSet:FREQence 1000000

3.7.5.22 Clear Marker ([:SOURce]:RADio:ARB:MARKer:CLEar)

Command	[:SOURce]:RADio:ARB:MARKer:CLEar
Format	"<file_name>",<marker>,<first_point>,<last_point>
Instruction	This command clears a single marker point or a range of marker points on a waveform segment for the selected marker (1-4)
Parameter Type	String, Integer, Integer, Integer
Parameter Range	None, 1 ~ 4, 1 ~ point of <file_name>, <first_point> ~ point of <file_name>,
Return	None
Default	None
Menu	None
Example	:RADio:ARB:MARKer:CLEar "SINE_WAVE",1,1,10

3.7.5.23 Clear All Marker

([:SOURce]:RADio:ARB:MARKer:CLEar:ALL)

Command Format	[:SOURce]:RADio:ARB:MARKer:CLEar:ALL <segment>,<marker>
Instruction	This command clears all marker points on a waveform segment for the selected marker (1-4)

Parameter Type	String, Integer
Parameter Range	None, 1 ~ 4
Return	None
Default	None
Menu	ARB > Marker Utilities > Set Markers->Clear
Example	:RADio:ARB:MARKer:CLEar:ALL "SINE_WAVE",1

3.7.5.24 Rotate Marker (:MARKer:ROTate)

Command Format	[:SOURce]:RADio:ARB:MARKer:ROTate "<file_name>",<rotate_count>
Instruction	This command shifts the marker points for all markers in a waveform segment earlier or later by the value of the <rotate_count> variable
Parameter Type	String, Integer
Parameter Range	None, -(n - 1) to (n - 1). n = number of points in the waveform
Return	None
Default	None
Menu	None
Example	:RADio:ARB:MARKer:ROTate "SINE_WAVE",10

3.7.5.25 Set Marker ([:SOURce]:RADio:ARB:MARKer:[SET])

Command Format	[:SOURce]:RADio:ARB:MARKer:[SET] "<file_name>",<marker>,<first_point>,<last_point>,<skip_count>
Instruction	This command sets a single marker point or a range of marker points on a waveform segment for the selected marker (1-4)
Parameter Type	String, Integer, Integer, Integer, Integer
Parameter Range	None, 1 ~ 4, 1 ~ point of <file_name>, <first_point> ~ point of <file_name>, 0 ~ <last_point> - <first_point>
Return	None
Default	None
Menu	None

SIGLENT

Example	:RADio:ARB:MARKer "SINE_WAVE",1,10,20,5
---------	---

3.7.5.26 Marker Polarity

([:SOURce]:RADio:ARB:MPOLarity:MARKer1|2|3|4)

Command	[:SOURce]:RADio:ARB:MPOLarity:MARKer1 2 3 4 NEG POS
Format	[:SOURce]:RADio:ARB:MPOLarity:MARKer1 2 3 4?
Instruction	This command sets the polarity for the selected marker. For a positive marker polarity, the marker signal is high during the marker points. For a negative marker polarity, the marker signal is high during the period of no marker points
Parameter Type	Enumeration
Parameter Range	NEG POS
Return	Enumeration
Default	NEGative
Menu	ARB > Marker Utilities > Marker Polarity
Example	:RADio:ARB:MPOLarity:MARKer1 NEG

3.7.5.27 Marker Output ([:SOURce]:RADio:ARB:MARKer:OUTPut)

Command	[:SOURce]:RADio:ARB:MARKer:OUTPut
Format	None Marker1 Marker2 Marker3 Marker4 [:SOURce]:RADio:ARB:MARKer:OUTPut?
Instruction	This command enables or disables the marker output for the selected marker
Parameter Type	Enumeration
Parameter Range	None Marker1 Marker2 Marker3 Marker4
Return	Enumeration
Default	Marker1
Menu	ARB > Marker Utilities > Output
Example	:RADio:ARB:MPOLarity:MARKer:OUTPut Maker2

3.7.5.28 Pulse/RF Blank

([:SOURce]:RADio:ARB:MDEStination:PULSe)

Command	[:SOURce]:RADio:ARB:MDEStination:PULSe
Format	None Marker1 Marker2 Marker3 Marker4 [:SOURce]:RADio:ARB:MDEStination:PULSe?
Instruction	This command enables or disables the marker pulse/RF blanking function for the selected marker
Parameter Type	Enumeration
Parameter Range	None Marker1 Marker2 Marker3 Marker4
Return	Enumeration
Default	None
Menu	ARB > Marker Utilities > Pulse/RF Blank
Example	:RADio:ARB:MDEStination:PULSe Marker2

3.7.5.29 Clipping ([:SOURce]:RADio:ARB:CLIPping)

Command	[:SOURce]:RADio:ARB:CLIPping "<file name>",IJQ IQRQ,<val>[,<val>]
Instruction	This command sets the clipping level of the selected waveform segment to a percentage of its highest peak
Parameter Type	String, Enumeration, Float, Float
Parameter Range	None, IJQ IQRQ, 0.01 ~ 1, 0.01 ~ 1
Return	None
Default	None
Menu	ARB > Waveform Utilities > Clipping
Example	:RADio:ARB:CLIPping "SINE_WAVE",IJQ,0.75

3.7.5.30 Scaling ([:SOURce]:RADio:ARB:SCaling)

Command	[:SOURce]:RADio:ARB:SCaling "<file name>",<val>
---------	---

SIGLENT

Instruction	This command scales the designated "<file_name>" waveform file
Parameter Type	String, Float
Parameter Range	None, 0.01 ~ 1
Return	None
Default	None
Menu	ARB > Waveform Utilities > Apply to Waveform
Example	:RADio:ARB:SCaling "SINE_WAVE",0.75

3.7.5.31 Arb Modulation Filter Type

([:SOURce]:IQ:DUALarb:FILTer:TYPE)

Command	[:SOURce]:IQ:DUALarb:FILTer:TYPE <type>
Format	[:SOURce]:IQ:DUALarb:FILTer:TYPE?
Instruction	This command specifies the ARB Modulation filter type
Parameter Type	Enumeration
Parameter Range	NONE RAISecosine ROOTcosine GAUSSian HSINE
Return	Enumeration
Default	ROOTcosine
Menu	ARB > ARB Setup > Modulation Filter > Filter Type
Example	:IQ:DUALarb:FILTer:TYPE GAUSSian

3.7.5.32 Arb Modulation Filter Alpha

([:SOURce]:IQ:DUALarb:FILTer:ALPHa)

Command	[:SOURce]:IQ:DUALarb:FILTer:ALPHa <val>
Format	[:SOURce]:IQ:DUALarb:FILTer:ALPHa?
Instruction	This command changes the Nyquist or root Nyquist filter's alpha value or Caussian's BT value
Parameter Type	Float
Parameter Range	0.010 ~ 1.000

Return	Float
Default	0.35
Menu	ARB > ARB Setup > Modulation Filter > Filter Alpha
Example	:IQ:DUALarb:FILTer:ALPHa 0.22

3.7.5.33 Arb Modulation Filter Length ([:SOURce]:IQ:DUALarb:FILTer:LENGth)

Command	[:SOURce]:IQ:DUALarb:FILTer:LENGth <len>
Format	[:SOURce]:IQ:DUALarb:FILTer:LENGth?
Instruction	This command changes the length of filter
Parameter Type	Integer
Parameter Range	1 ~ 512
Return	Integer
Default	128
Menu	ARB > ARB Setup > Modulation Filter > Filter Length
Example	:IQ:DUALarb:FILTer:LENGth 64

3.7.5.34 Arb Modulation Filter OverSampling ([:SOURce]:IQ:DUALarb:OVERsampling)

Command	[:SOURce]:IQ:DUALarb:OVERsampling <val>
Format	[:SOURce]:IQ:DUALarb:OVERsampling?
Instruction	This command changes the over-sample value of filter
Parameter Type	Integer
Parameter Range	2 ~ 32
Return	Integer
Default	2
Menu	ARB > ARB Setup > Modulation Filter > OverSampling
Example	:IQ:DUALarb:OVERsampling 4

3.7.5.35 Arb Modulation Filter Update

([:SOURce] :IQ:DUALarb:FILTer:UPDAte)

Command Format	[:SOURce] :IQ:DUALarb:FILTer:UPDAte
Instruction	This command updates the data filtering
Parameter Type	Integer
Parameter Range	2 ~ 32
Return	Integer
Default	2
Menu	ARB > ARB Setup > Modulation Filter > Update
Example	:IQ:DUALarb:FILTer:UPDAte

3.7.5.36 Arb Trigger Type ([:SOURce]:IQ:DUALarb:TRIGger:TYPE)

Command Format	[:SOURce]:IQ:DUALarb:TRIGger:TYPE CONTInous SINGle SADVance GATE [:SOURce]:IQ:DUALarb:TRIGger:TYPE?
Instruction	Select the trigger type for arb mode Get the trigger type for arb mode
Parameter Type	Enumeration
Parameter Range	CONTInous SINGle SADVance GATE
Return	Enumeration
Default	CONTInous
Menu	IQ MOD > ARB > Trigger > Trigger Type
Example	:IQ:DUALarb:TRIGger:TYPE SADVance

3.7.5.37 Arb Trigger Source ([:SOURce]:IQ:DUALarb:TRIGger: SOURce)

Command Format	[:SOURce]:IQ:DUALarb:TRIGger:SOURce KEY BUS EXT [:SOURce]:IQ:DUALarb:TRIGger:SOURce?
Instruction	Select the trigger source for arb mode

	Get the trigger source for arb mode
Parameter Type	Enumeration
Parameter Range	KEY BUS EXT
Return	Enumeration
Default	KEY
Menu	IQ MOD > ARB > Trigger > Trigger Source
Example	:IQ:DUALarb:TRIGger:SOURce BUS

3.7.5.38 Arb Trigger Continuous Mode

([:SOURce]:IQ:DUALarb:TRIGger:CONTInous)

Command Format	[:SOURce]:IQ:DUALarb:TRIGger:CONTInous FREErun RUNIgnored RUNRestart [:SOURce] :IQ:DUALarb:TRIGger:CONTInous?
Instruction	Select the continuous mode for arb trigger Get the continuous mode for arb trigger
Parameter Type	Enumeration
Parameter Range	FREErun RUNIgnored RUNRestart
Return	Enumeration
Default	FREErun
Menu	IQ MOD > ARB > Trigger > Continuous Mode
Example	:IQ:DUALarb:TRIGger:CONTInous RUNIgnored

3.7.5.39 Arb Trigger Single Mode ([:SOURce]:IQ:DUALarb:TRIGger:SINGle)

Command Format	[:SOURce]:IQ:DUALarb:TRIGger:SINGle NOREtrigger BUFFeredtrig NOREtrigger [:SOURce]:IQ:DUALarb:TRIGger:SINGle?
Instruction	Select the single mode for arb mode Get the single mode for arb mode
Parameter	Enumeration

SIGLENT

Type	
Parameter Range	NOREtrigger BUFFeredtrig NOREtrigger
Return	Enumeration
Default	NOREtrigger
Menu	IQ MOD > ARB > Trigger > Single Mode
Example	:IQ:DUALarb:TRIGger:SINGLE BUFFeredtrig

3.7.5.40 Arb Trigger Segment Mode

([:SOURce]:IQ:DUALarb:TRIGger: SEGMENT)

Command Format	[:SOURce]:IQ:DUALarb:TRIGger:SEGMENT SINGLE CONTInous [:SOURce]:IQ:DUALarb:TRIGger:SEGMENT?
Instruction	Select the segment mode for arb mode Get the segment mode for arb mode
Parameter Type	Enumeration
Parameter Range	SINGLE CONTInous
Return	Enumeration
Default	CONTInous
Menu	IQ MOD > ARB > Trigger > Segment Mode
Example	:IQ:DUALarb:TRIGger: SEGMENT SINGLE

3.7.5.41 Arb Trigger Gate Mode ([:SOURce]:IQ:DUALarb:TRIGger: GATE)

Command Format	[:SOURce]:IQ:DUALarb:TRIGger:GATE LOW HIGHt [:SOURce]:IQ:DUALarb:TRIGger:GATE?
Instruction	Select the gate mode for arb mode Get the gate mode for arb mode
Parameter Type	Enumeration
Parameter Range	LOW HIGHt
Return	Enumeration

Default	HIGHt
Menu	IQ MOD > ARB > Trigger > Gate Mode
Example	:IQ:DUALarb:TRIGger: GATE LOW

3.7.5.42 Arb Trigger Polarity ([:SOURce]:IQ:DUALarb:TRIGger: POL)

Command	[:SOURce]:IQ:DUALarb:TRIGger:POL POS NEG
Format	[:SOURce]:IQ:DUALarb:TRIGger:POL?
Instruction	Select the external polarity for arb trigger Get the external polarity for arb trigger
Parameter Type	Enumeration
Parameter Range	POS NEG
Return	Enumeration
Default	POS
Menu	IQ MOD > ARB > Trigger > Ext Polarity
Example	:IQ:DUALarb:TRIGger:POL NEG

3.7.5.43 Arb Trigger Delay Type

([:SOURce] :IQ:DUALarb:TRIGger:DELAy:TYPE)

Command	[:SOURce] :IQ:DUALarb:TRIGger:DELAy:TYPE OFF TIME SAMPlE
Format	[:SOURce] :IQ:DUALarb:TRIGger:DELAy:TYPE?
Instruction	Select the delay type for arb trigger Get the delay type for arb trigger
Parameter Type	Enumeration
Parameter Range	OFF TIME SAMPlE
Return	Enumeration
Default	OFF
Menu	IQ MOD > ARB > Trigger > Delay Type
Example	:IQ:DUALarb:TRIGger:DELAy:TYPE TIME

3.7.5.44 Arb Trigger Delay Time

([:SOURce] :IQ:DUALarb:TRIGger:DELAy:Time)

Command	[:SOURce] :IQ:DUALarb:TRIGger:DELAy:Time <time>
Format	[:SOURce] :IQ:DUALarb:TRIGger:DELAy:Time?
Instruction	set the delay time for arb trigger Get the delay time for arb trigger
Parameter Type	Float, unit: ns, us, ms, s
Parameter Range	0 ~ 40s
Return	Float,s
Default	0
Menu	IQ MOD > ARB > Trigger > Delay Time
Example	:IQ:DUALarb:TRIGger:DELAy:Time 10

3.7.5.45 Arb Trigger Delay Samples

([:SOURce] :IQ:DUALarb:TRIGger:DELAy:SAMPlE)

Command	[:SOURce] :IQ:DUALarb:TRIGger:DELAy:SAMPlE <samples>
Format	[:SOURce] :IQ:DUALarb:TRIGger:DELAy:SAMPlE?
Instruction	Select the delay samples for arb trigger Get the delay samples for arb trigger
Parameter Type	Integer
Parameter Range	0 ~ 100000000
Return	Integer
Default	0
Menu	IQ MOD > ARB > Trigger > Delay Samples
Example	:IQ:DUALarb:TRIGger:DELAy:SAMPlE TIME

3.7.5.46 Arb Trigger ([:SOURce]:IQ:DUALarb:*TRG)

Command	[:SOURce]:IQ:DUALarb:*TRG
Format	

Instruction	Send a trigger signal for the bus source.
Parameter Type	
Parameter Range	
Return	
Default	
Menu	IQ MOD > ARB > Trigger
Example	:IQ:DUALarb:*TRG

3.7.6 [:SOURce]:RADio:AWGN Subsystem

3.7.6.1 AWGN State (:SOURce):RADio:AWGN:RT[:STATe])

Command	[:SOURce]:RADio:AWGN:RT[:STATe] ON OFF 1 0
Format	[:SOURce]:RADio:AWGN:RT[:STATe]?
Instruction	This command enables or disables the operating state of real-time AWGN
Parameter Type	Boolean
Parameter Range	ON OFF 1 0
Return	Boolean
Default	0
Menu	AWGN > AWGN State
Example	:RADio:AWGN:RT 1

3.7.6.2 Bandwidth (:SOURce):RADio:AWGN:RT:BWIDth)

Command	[:SOURce]:RADio:AWGN:RT:BWIDth <bandwidth>
Format	[:SOURce]:RADio:AWGN:RT:BWIDth?
Instruction	This command adjusts the real-time AWGN bandwidth value
Parameter Type	Float, unit: Hz, kHz, MHz, GHz, Default "Hz"
Parameter Range	1 Hz ~ 150 MHz

SIGLENT

Return	Float
Default	10 MHz
Menu	AWGN > Bandwidth
Example	:RADio:AWGN:RT:BWIDth 1000000

3.7.7 [:SOURce]:DM Subsystem

3.7.7.1 I/Q Mod State ([:SOURce]:DM:STATE)

Command	[:SOURce]:DM:STATE ON OFF 1 0
Format	[:SOURce]:DM:STATE?
Instruction	This command enables or disables the I/Q modulator
Parameter Type	Boolean
Parameter Range	ON OFF 1 0
Return	Boolean
Default	0
Menu	I/Q Control > I/Q Mod State
Example	:DM:STATE ON

3.7.7.2 I/Q Source ([:SOURce]:DM:SOURce)

Command	[:SOURce]:DM:SOURce EXTernal INTernal
Format	[:SOURce]:DM:SOURce?
Instruction	This command selects the I/Q modulator source
Parameter Type	Enumeration
Parameter Range	EXTernal INTernal
Return	Enumeration
Default	INTernal
Menu	I/Q Control > I/Q Source
Example	:DM:SOURce EXTernal

3.7.7.3 Compensation Channel ([:SOURce]:DM:BW:CAL:LINK)

Command	[:SOURce]:DM:BW:CAL:LINK RF OUTPut OFF
Format	[:SOURce]:DM:BW:CAL:LINK?
Instruction	This command select broadband compensation links
Parameter Type	Enumeration
Parameter Range	RF OUTPut OFF
Return	Enumeration
Default	RF
Menu	I/Q Control > Compensation Channel
Example	:DM:BW:CAL:LINK RF

3.7.7.4 I/Q Adjustment ([:SOURce]:DM:IQADjustment[:STATe])

Command	[:SOURce]:DM:IQADjustment[:STATe] <state>
Format	[:SOURce]:DM:IQADjustment[:STATe]?
Instruction	This command enables or disables the I/Q adjustments
Parameter Type	Boolean
Parameter Range	ON OFF 1 0
Return	Boolean
Default	1
Menu	I/Q Control > I/Q Adjustment
Example	:DM:IQADjustment 1

3.7.7.5 Gain Balance ([:SOURce]:DM:IQADjustment:GAIN)

Command	[:SOURce]:DM:IQADjustment:GAIN <val>
Format	[:SOURce]:DM:IQADjustment:GAIN?
Instruction	This command sets the gain for the I signal relative to the Q signal
Parameter Type	Float
Parameter Range	-4 ~ 4

SIGLENT

Range	
Return	Float
Default	0
Menu	I/Q Control > I/Q Adjustment > Gain Balance
Example	:DM:IQADjustment:GAIN 1

3.7.7.6 I Offset ([:SOURce]:DM:IQADjustment:IOFFset)

Command	[:SOURce]:DM:IQADjustment:IOFFset <val>
Format	[:SOURce]:DM:IQADjustment:IOFFset?
Instruction	This command adjusts the I channel offset value
Parameter Type	Float
Parameter Range	-50 ~ 50
Return	Float
Default	0
Menu	I/Q Control > I/Q Adjustment > I Offset
Example	:DM:IQADjustment:IOFFset 1

3.7.7.7 Q Offset ([:SOURce]:DM:IQADjustment:QOFFset)

Command	[:SOURce]:DM:IQADjustment:QOFFset <val>
Format	[:SOURce]:DM:IQADjustment:QOFFset?
Instruction	This command adjusts the Q channel offset value
Parameter Type	Float
Parameter Range	-50 ~ 50
Return	Float
Default	0
Menu	I/Q Control > I/Q Adjustment > Q Offset
Example	:DM:IQADjustment:QOFFset 1

3.7.7.8 Q Angle Adjustment ([:SOURce]:DM:IQADjustment:QSKEW)

Command	[:SOURce]:DM:IQADjustment:QSKEW <val>
---------	---------------------------------------

Format	[[:SOURce]:DM:IQADjustment:QSKEW?
Instruction	This command adjusts the phase angle (quadrature skew) between the I and Q vectors by increasing or decreasing the Q phase angle. It affects only the RF output path
Parameter Type	Float
Parameter Range	-10 ~ 10
Return	Float
Default	0
Menu	I/Q Control > I/Q Adjustment > Quad Angle Adjustment
Example	:DM:IQADjustment:QSKEW 1

3.7.7.9 I/Q Output ([[:SOURce]:DM:IQADjustment:EXTernal[:STATe])

Command	[[:SOURce]:DM:IQADjustment:EXTernal[:STATe] ON OFF 1 0
Format	[[:SOURce]:DM:IQADjustment:EXTernal[:STATe]?
Instruction	This command enables or disables the I/Q output
Parameter Type	Boolean
Parameter Range	ON OFF 1 0
Return	Boolean
Default	0
Menu	I/Q Control > I/Q Output
Example	:DM:IQADjustment:EXTernal 1

3.7.7.10 I/Q Output Atten

([[:SOURce]:DM:IQADjustment:EXTernal:IQATten)

Command	[[:SOURce]:DM:IQADjustment:EXTernal:IQATten <val>
Format	[[:SOURce]:DM:IQADjustment:EXTernal:IQATten?
Instruction	This command sets the I/Q output attenuation level (dB).
Parameter Type	Float
Parameter Range	0 ~ 20

SIGLENT

Range	
Return	Float
Default	0
Menu	I/Q Control > I/Q Output > I/Q Output Atten
Example	:DM:IQADjustment:EXTernal:IQATten 1

3.7.7.11 I/Q Output Gain Balance

([:SOURce]:DM:IQADjustment:EXTernal:GAIN)

Command	[:SOURce]:DM:IQADjustment:EXTernal:GAIN <val>
Format	[:SOURce]:DM:IQADjustment:EXTernal:GAIN?
Instruction	This command sets the I/Q gain ratio for signals routed to the rear panel I and Q output connectors The variable <val> is expressed in units of decibels (dB)
Parameter Type	Float
Parameter Range	-4 ~ 4
Return	Float
Default	0
Menu	I/Q Control > I/Q Output > I/Q Output Gain Balance
Example	:DM:IQADjustment:EXTernal:GAIN 1

3.7.7.12 I Output Offset

([:SOURce]:DM:IQADjustment:EXTernal:DIOffset)

Command	[:SOURce]:DM:IQADjustment:EXTernal:DIOffset <val>
Format	[:SOURce]:DM:IQADjustment:EXTernal:DIOffset?
Instruction	This command sets the differential offset voltage for an in-phase (I) signal routed to the I output connectors The variable <val> is expressed in units of volts (mV-V)
Parameter Type	Float
Parameter Range	-3 V ~ 3 V
Return	Float

Default	0 mV
Menu	I/Q Control > I/Q Output > I Output Offset
Example	:DM:IQADjustment:EXTernal:DIOffset 1

3.7.7.13 Q Output Offset ([:SOURce]:DM:IQADjustment:DQOFFset)

Command	[:SOURce]:DM:IQADjustment:EXTernal:DQOFFset <val>
Format	[:SOURce]:DM:IQADjustment:EXTernal:DQOFFset?
Instruction	This command sets the differential offset voltage for an a quadrature-phase (Q) signal routed to the Q output connectors
Parameter Type	Float
Parameter Range	-3 V ~ 3 V
Return	Float
Default	0 mV
Menu	I/Q Control > I/Q Output > Q Output Offset
Example	:DM:IQADjustment:EXTernal:DQOFFset 1

3.7.7.14 I/Q Common Offset

([:SOURce]:DM:IQADjustment:EXTernal:COFFset)

Command	[:SOURce]:DM:IQADjustment:EXTernal:COFFset <val>
Format	[:SOURce]:DM:IQADjustment:EXTernal:COFFset?
Instruction	This command sets the common mode offset voltage for both the in-phase (I) and quadrature-phase(Q) signals going to the rear panel I and Q output connectors.
Parameter Type	Float
Parameter Range	-3 V ~ 3 V
Return	Float
Default	0 mV
Menu	I/Q Control > I/Q Output > I/Q Common Offset
Example	:DM:IQADjustment:EXTernal:COFFset 1

3.7.8 [:SOURce]:IQ:DUALarb Subsystem

3.7.8.1 Get Segment Name

([:SOURce]:IQ:DUALarb:SEGMENT:NAMES?)

Command Format	[:SOURce]:IQ:DUALarb:SEGMENT:NAMES?
Instruction	Get the names of all waveform segments
Parameter Type	None
Parameter Range	None
Return	String
Default	RAMP_WAVE 200 SINE_WAVE 200
Menu	ARB > Waveform Segment
Example	:IQ:DUALarb:SEGMENT:NAMES?

3.7.8.2 Load Segment ([:SOURce]:IQ:DUALarb:SEGMENT:LOAD)

Command Format	[:SOURce]:IQ:DUALarb:SEGMENT:LOAD "<file_name>" [:SOURce]:IQ:DUALarb:SEGMENT:LOAD:DATA "<file_name>" [:SOURce]:IQ:DUALarb:SEGMENT:LOAD:TEXT "<file_name>"
Instruction	This command loads the waveform file
Parameter Type	String
Parameter Range	None
Return	None
Default	None
Menu	ARB > Waveform Segment > Load
Example	:IQ:DUALarb:SEGMENT:LOAD "Local/SINE_WAVE.arb" :IQ:DUALarb:SEGMENT:LOAD:DATA "Local/WAVE.wd" :IQ:DUALarb:SEGMENT:LOAD:TEXT "Local/SINE_WAVE.wdtx"

3.7.8.3 Delete Segment ([:SOURce]:IQ:DUALarb:SEGMent:DEL)

Command Format	[:SOURce]:IQ:DUALarb:SEGMent:DEL "<file_name>"
Instruction	This command deletes the waveform segment
Parameter Type	String
Parameter Range	None
Return	None
Default	None
Menu	ARB > Waveform Segment > Delete
Example	:IQ:DUALarb:SEGMent:DEL "SINE_WAVE"

3.7.8.4 Rename Segment

([:SOURce]:IQ:DUALarb:SEGMent:RENAme)

Command Format	[:SOURce]:IQ:DUALarb:SEGMent:RENAme "<old_name>","<new_name>"
Instruction	This command renames the waveform segment
Parameter Type	String, String
Parameter Range	None
Return	None
Default	None
Menu	ARB > Waveform Segment > Rename
Example	:IQ:DUALarb:SEGMent:RENAme "SINE_WAVE","RENAME_WAVE"

3.7.8.5 Clear Segment ([:SOURce]:IQ:DUALarb:SEGMent:CLEAR)

Command Format	[:SOURce]:IQ:DUALarb:SEGMent:CLEAR
Instruction	This command deletes all waveform segments
Parameter Type	None

SIGLENT

Parameter Range	None
Return	None
Default	None
Menu	ARB > Waveform Segment > Clear
Example	:IQ:DUALarb:SEGMENT:CLEAr

3.7.8.6 Header Info ([:SOURce]:IQ:DUALarb:HEADer:INFO?)

Command Format	[:SOURce]:IQ:DUALarb:HEADer:INFO?
Instruction	This command gets waveform header information
Parameter Type	None
Parameter Range	None
Return	String
Default	discript= rms=Unspecified sampling rate=Unspecified marker1 polary=Unspecified marker2 polary=Unspecified marker3 polary=Unspecified marker4 polary=Unspecified rf marker=Unspecified output marker=Unspecified atten type=Unspecified atten value=Unspecified noise state=Unspecified noise output=Unspecified noise power control=Unspecified noise total power=Unspecified noise carrier power=Unspecified noise noise power=Unspecified channel noise power=Unspecified carrier to noise ratio format=Unspecified

	carrier to noise ratio=Unspecified bit to noise ratio=Unspecified carrier bit ratio=Unspecified carrier bandwidth=Unspecified noise bandwidth=Unspecified baseband offset state=Unspecified baseband offset freq=Unspecified
Menu	ARB > Waveform Header
Example	:IQ:DUALarb:HEADer:INFO?

3.7.8.7 Clear Header ([:SOURce]:IQ:DUALarb:HEADer:CLEAr)

Command Format	[:SOURce]:IQ:DUALarb:HEADer:CLEAr
Instruction	This command clear waveform header information
Parameter Type	None
Parameter Range	None
Return	None
Default	None
Menu	ARB > Waveform Segment > Clear Header
Example	:IQ:DUALarb:HEADer:CLEAr

3.7.8.8 Store Header ([:SOURce]:IQ:DUALarb:HEADer:STORE)

Command Format	[:SOURce]:IQ:DUALarb:HEADer:STORE
Instruction	This command stores waveform header information
Parameter Type	None
Parameter Range	None
Return	None
Default	None
Menu	ARB > Waveform Segment > Save To Header
Example	:IQ:DUALarb:HEADer:STORE

3.7.8.9 Describe ([:SOURce]:IQ:DUALarb:HEADer:DESCribt)

Command	[:SOURce]:IQ:DUALarb:HEADer:DESCribt "<describe>"
Format	[:SOURce]:IQ:DUALarb:HEADer:DESCribt?
Instruction	This command sets or gets description
Parameter Type	None
Parameter Range	None
Return	None
Default	None
Menu	ARB > Waveform Segment > Describe
Example	:IQ:DUALarb:HEADer:DESCribt "INFO"

3.7.9:MEMory Subsystem

3.7.9.1 Save Segment (:MEMory:COpy[:NAME])

Command Format	:MEMory:COpy[:NAME] "<file name>","<file name>"
Instruction	Copy a waveform file from volatile to non-volatile memory
Parameter Type	String, String
Parameter Range	None, None
Return	None
Default	None
Menu	ARB > Waveform Segment > Save
Example	:MEMory:COpy "SINE_WAVE","SINE_WAVE.arb"

3.7.9.2 Create Segment (:MEM:DATA)

Command Format	:MEM:DATA "<file_name>",<data_block>
Instruction	This command loads waveform data into signal generator memory using the <data_block> parameter and saves the data to a file designated by the

	"<file_name>" variable
Parameter Type	String, String
Parameter Range	None, None
Return	None
Default	None
Menu	None
Example	:MEM:DATA "NVWFM:IQ_Data.arb",#14Y9oL

3.7.9.3 User Data (:MEM:DATA:BIT)

Command Format	:MEM:DATA:BIT "<file_name>",<bit_count>,<data_block>
Instruction	<p>This command loads bit data into signal generator memory using the <bit_count> and <data_block> parameters and saves the data to a file designated by the "<file_name>" variable.</p> <p>"<file_name>" This variable names the destination file and the directory path.</p> <p><bit_count> This number represents the number of bits in the data block.</p> <p><data_block> This parameter represents the data and file length parameters.</p>
Parameter Type	String, Integer, String
Parameter Range	None, 1 ~ 10000000, None
Return	None
Default	None
Menu	None
Example	:MEM:DATA:BIT "Test_Data.udata",16,#12Qz

4. Programming Examples

This chapter gives some examples for the programmer. In these examples you can see how to use the VISA or sockets, in combination with the commands have been described above to control the signal generator. By following these examples, you can develop many more applications.

4.1 VISA Examples

4.1.1 VC++ Example

Environment: Win7 32bit system, Visual Studio

The functions of this example: Use National Instruments NI-VISA to control the device with USBTMC or TCP/IP access and perform write and read operations.

Follow the steps to finish the example:

1. Open Visual Studio, create a new VC++ win32 console project.
2. Set the project environment to use the NI-VISA lib, there are two ways to use NI-VISA, static or automatic:

(1) Static: find files: visa.h, visatype.h, visa32.lib in NI-VISA install path. Copy them to your project, and add them into project. In the projectname.cpp file, add the follow two lines:

```
#include "visa.h"  
#pragma comment(lib,"visa32.lib")
```

(2) Automatic:

Set the .h file include directory, the NI-VISA install path, in our computer we set the path is: C:\Program Files\IVI Foundation\VISAWinNT\include. Set this path to project---properties---c/c++---General---Additional Include Directories: See the picture:

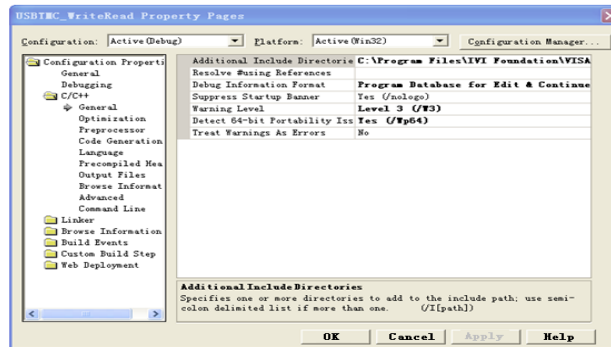

Set lib path set lib file:

Set lib path: the NI-VISA install path, in our computer we set the path is: C:\Program Files\IVI Foundation\VISA\WinNT\lib\msc. Set this path to project---properties---Linker---General---Additional Library Directories: as seen in the pictures below.

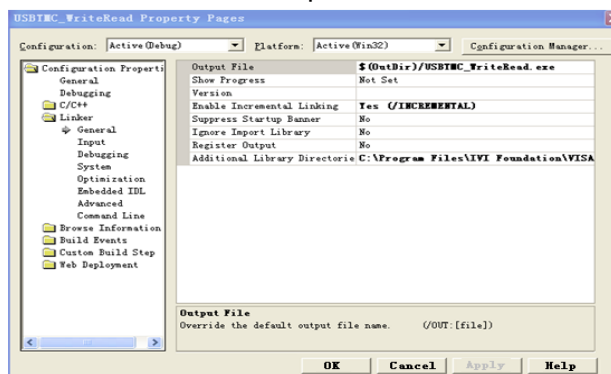

Set lib file: project---properties---Linker---Command Line---Additional Options: visa32.lib

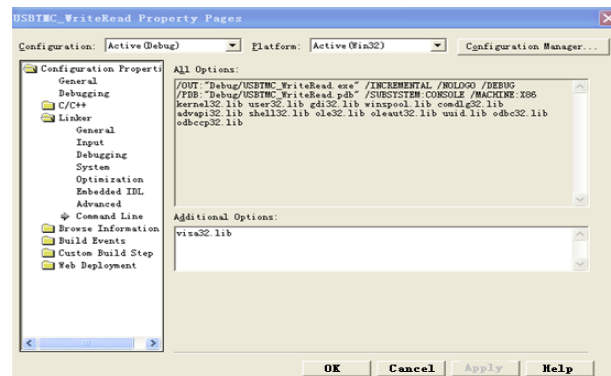

Include visa.h file: In the projectname.cpp file:

```
#include <visa.h>
```

3. Add the following code:

(1) USBTMC access code.

Write a function Usbtmc_test:

```
int Usbtmc_test()
```

```
{
```

```
/* This code demonstrates sending synchronous read & write commands */
```

SIGLENT

```
/* to an USB Test & Measurement Class (USBTMC) instrument using */
/* NI-VISA */
/* The example writes the "*IDN?\n" string to all the USBTMC */
/* devices connected to the system and attempts to read back */
/* results using the write and read functions. */
/* The general flow of the code is */
/* Open Resource Manager */
/* Open VISA Session to an Instrument */
/* Write the Identification Query Using viPrintf */
/* Try to Read a Response With viScanf */
/* Close the VISA Session */
/*****/
ViSession defaultRM;
ViSession instr;
ViUInt32 numInstrs;
ViFindList findList;
ViStatus status;
char instrResourceString[VI_FIND_BUFLLEN];
unsigned char buffer[100];
int i;
/** First we must call viOpenDefaultRM to get the manager
 * handle. We will store this handle in defaultRM.*/
status = viOpenDefaultRM (&defaultRM);
if (status<VI_SUCCESS)
{
printf ("Could not open a session to the VISA Resource Manager!\n");
returnstatus;
}
/* Find all the USB TMC VISA resources in our system and store the number of resources in the system in
numInstrs.*/
status = viFindRsrc (defaultRM, "USB?*INSTR", &findList, &numInstrs, instrResourceString);
if (status<VI_SUCCESS)
{
printf ("An error occurred while finding resources.\nPress 'Enter' to continue.");
fflush(stdin);
getchar();
viClose (defaultRM);
returnstatus;
}
/** Now we will open VISA sessions to all USB TMC instruments.
 * We must use the handle from viOpenDefaultRM and we must
 * also use a string that indicates which instrument to open. This
 * is called the instrument descriptor. The format for this string
 * can be found in the function panel by right clicking on the
```



```
* descriptor parameter. After opening a session to the
* device, we will get a handle to the instrument which we
* will use in later VISA functions. The AccessMode and Timeout
* parameters in this function are reserved for future
* functionality. These two parameters are given the value VI_NULL.*/
for (i=0; i<int(numInstrs); i++)
{
if (i> 0)
{
viFindNext (findList, instrResourceString);
}
status = viOpen (defaultRM, instrResourceString, VI_NULL, VI_NULL, &instr);
if (status<VI_SUCCESS)
{
printf ("Cannot open a session to the device %d.\n", i+1);
continue ;
}
/* * At this point we now have a session open to the USB TMC instrument.
* We will now use the viPrintf function to send the device the string "*IDN?\n",
* asking for the device's identification. */
char * cmmmand ="*IDN?\n";
status = viPrintf (instr, cmmmand);
if (status<VI_SUCCESS)
{
printf ("Error writing to the device %d.\n", i+1);
status = viClose (instr);
continue;
}
/** Now we will attempt to read back a response from the device to
* the identification query that was sent. We will use the viScanf
* function to acquire the data.
* After the data has been read the response is displayed. */
status = viScanf(instr, "%t", buffer);
if (status<VI_SUCCESS)
{
printf ("Error reading a response from the device %d.\n", i+1);
}
else
{
printf ("\nDevice %d: %s\n", i+1, buffer);
}
status = viClose (instr);
}
/** Now we will close the session to the instrument using
```

SIGLENT

```
 * viClose. This operation frees all system resources.  */
status = viClose (defaultRM);
printf("Press 'Enter' to exit.");
fflush(stdin);
getchar();
return 0;
}

int _tmain(int argc, _TCHAR* argv[])
{
Usbtmc_test();
return 0;
}
```

The run result:

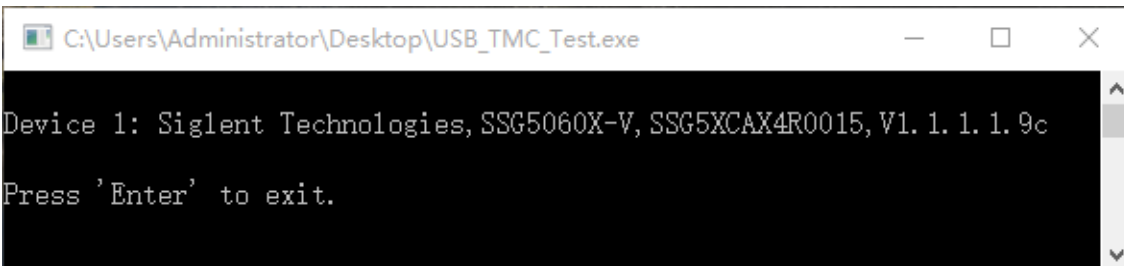

```
C:\Users\Administrator\Desktop\USB_TMC_Test.exe
Device 1: Siglent Technologies, SSG5060X-V, SSG5XCAX4R0015, V1.1.1.1.9c
Press 'Enter' to exit.
```

(2) TCP/IP access code.

Write a function TCP_IP_Test:

```
int TCP_IP_Test(char *pIP)
{
char outputBuffer[VI_FIND_BUFLLEN];
ViSession defaultRM, instr;
ViStatus status;

/* First we will need to open the default resource manager. */
status = viOpenDefaultRM (&defaultRM);
if (status<VI_SUCCESS)
{
printf("Could not open a session to the VISA Resource Manager!\n");
}

/* Now we will open a session via TCP/IP device */
char head[256] = "TCPIP0::";
char tail[] = "::INSTR";

strcat(head,pIP);
```

```
strcat(head,tail);
status = viOpen (defaultRM, head, VI_LOAD_CONFIG, VI_NULL, &instr);
if (status<VI_SUCCESS)
{
printf ("An error occurred opening the session\n");
viClose(defaultRM);
}
status = viPrintf(instr, "*idn?\n");
status = viScanf(instr, "%t", outputBuffer);
if (status<VI_SUCCESS)
{
printf("viRead failed with error code: %x \n",status);
viClose(defaultRM);
}
else
{
printf ("\nMesseage read from device: %*s\n", 0,outputBuffer);
}
status = viClose (instr);
status = viClose (defaultRM);
printf("Press 'Enter' to exit.");
fflush(stdin);
getchar();
return 0;
}

int _tmain(int argc, _TCHAR* argv[])
{
printf("Please input IP address:");
char ip[256];
fflush(stdin);
gets(ip);
TCP_IP_Test(ip);
return 0;
}
```

The run result:

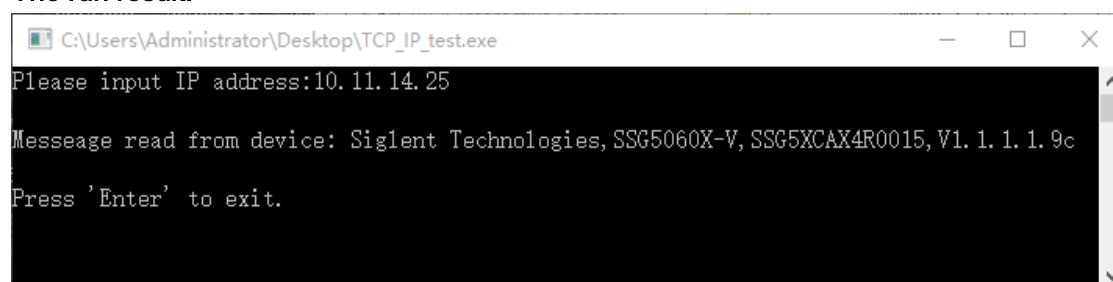

```
C:\Users\Administrator\Desktop\TCP_IP_test.exe
Please input IP address:10.11.14.25
Messeage read from device: Siglent Technologies, SSG5060X-V, SSG5XCAX4R0015, V1.1.1.1.9c
Press 'Enter' to exit.
```

4.1.2 VB Example

Environment: Win7 32bit system, Microsoft Visual Basic 6.0

The function of this example: Use National Instruments NI-VISA to control the device with USBTMC and TCP/IP access and perform write and read operations.

Follow the steps to complete the example:

1. Open Visual Basic, build a standard application program project (Standard EXE)
2. Set the project environment to use the NI-VISA lib, Click the Existing tab of Project>>Add Existing Item. Search for the visa32.bas file in the include folder under the NI-VISA installation path and add the file.

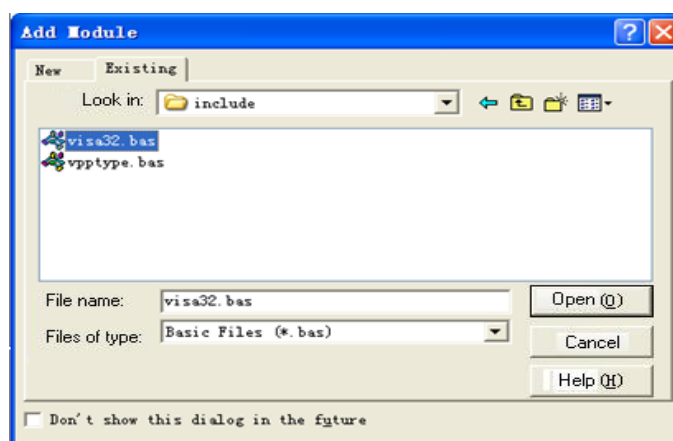

This allows the VISA functions and VISA data types to be used in a program.

3. Add the following code:

(1) USBTMC access code.

Write a function Usbtmc_test:

Private Function Usbtmc_test() **As Long**

```
' This code demonstrates sending synchronous read & write commands  
' to an USB Test & Measurement Class (USBTMC) instrument using  
' NI-VISA  
' The example writes the "**IDN?\n" string to all the USBTMC  
' devices connected to the system and attempts to read back
```

```

' results using the write and read functions.
' The general flow of the code is
' Open Resource Manager
' Open VISA Session to an Instrument
' Write the Identification Query Using viWrite
' Try to Read a Response With viRead
' Close the VISA Session
  Const MAX_CNT = 200

Dim defaultRM As Long
Dim instrsesn As Long
Dim numInstrs As Long
Dim findList As Long
Dim retCount As Long

Dim status As Long
Dim instrResourceString As String * VI_FIND_BUFLen
Dim Buffer As String * MAX_CNT
Dim i As Integer
' First we must call viOpenDefaultRM to get the manager
' handle. We will store this handle in defaultRM.
status = viOpenDefaultRM(defaultRM)
If (status < VI_SUCCESS) Then
  resultTxt.Text = "Could not open a session to the VISA Resource Manager!"
  Usbtmc_test = status
  Exit Function
End If

' Find all the USB TMC VISA resources in our system and store the
' number of resources in the system in numInstrs.
status = viFindRsrc(defaultRM, "USB?*INSTR", findList, numInstrs, instrResourceString)
If (status < VI_SUCCESS) Then
  resultTxt.Text = "An error occurred while finding resources."
  viClose(defaultRM)
  Usbtmc_test = status
  Exit Function
End If

' Now we will open VISA sessions to all USB TMC instruments.
' We must use the handle from viOpenDefaultRM and we must
' also use a string that indicates which instrument to open. This
' is called the instrument descriptor. The format for this string
' can be found in the function panel by right clicking on the
' descriptor parameter. After opening a session to the

```

```
' device, we will get a handle to the instrument which we
' will use in later VISA functions. The AccessMode and Timeout
' parameters in this function are reserved for future
' functionality. These two parameters are given the value VI_NULL.
For i = 0 To numInstrs
  If (i > 0) Then
    status = viFindNext(findList, instrResourceString)
  End If
  status = viOpen(defaultRM, instrResourceString, VI_NULL, VI_NULL, instrsesn)
  If (status < VI_SUCCESS) Then
    resultTxt.Text = "Cannot open a session to the device " + CStr(i + 1)
    GoTo NextFind
  End If

  ' At this point we now have a session open to the USB TMC instrument.
  ' We will now use the viWrite function to send the device the string "*IDN?",
  ' asking for the device's identification.
  status = viWrite(instrsesn, "*IDN?", 5, retCount)
  If (status < VI_SUCCESS) Then
    resultTxt.Text = "Error writing to the device."
    status = viClose(instrsesn)
    GoTo NextFind
  End If

  ' Now we will attempt to read back a response from the device to
  ' the identification query that was sent. We will use the viRead
  ' function to acquire the data.
  ' After the data has been read the response is displayed.
  status = viRead(instrsesn, Buffer, MAX_CNT, retCount)
  If (status < VI_SUCCESS) Then
    resultTxt.Text = "Error reading a response from the device." + CStr(i + 1)
  Else
    resultTxt.Text = "Read from device: " + CStr(i + 1) + " " + Buffer
  End If
  status = viClose(instrsesn)

Next i

' Now we will close the session to the instrument using
' viClose. This operation frees all system resources.
status = viClose(defaultRM)
Usbtmc_test = 0
End Function
```

(2) TCP/IP access code.

Write a function TCP_IP_Test:

```
Private Function TCP_IP_Test(ByVal ip As String) As Long
    Dim outputBuffer As String * VI_FIND_BUFLen
    Dim defaultRM As Long
    Dim instrsesn As Long
    Dim status As Long
    Dim count As Long

    ' First we will need to open the default resource manager.
    status = viOpenDefaultRM(defaultRM)
    If (status < VI_SUCCESS) Then
        resultTxt.Text = "Could not open a session to the VISA Resource Manager!"
        TCP_IP_Test = status
        Exit Function
    End If

    ' Now we will open a session via TCP/IP device
    status = viOpen(defaultRM, "TCPIP0:" + ip + "::INSTR", VI_LOAD_CONFIG, VI_NULL, instrsesn)
    If (status < VI_SUCCESS) Then
        resultTxt.Text = "An error occurred opening the session"
        viClose(defaultRM)
        TCP_IP_Test = status
        Exit Function
    End If

    status = viWrite(instrsesn, "*IDN?", 5, count)
    If (status < VI_SUCCESS) Then
        resultTxt.Text = "Error writing to the device."
    End If

    status = viRead(instrsesn, outputBuffer, VI_FIND_BUFLen, count)
    If (status < VI_SUCCESS) Then
        resultTxt.Text = "Error reading a response from the device." + CStr(i + 1)
    Else
        resultTxt.Text = "read from device:" + outputBuffer
    End If

    status = viClose(instrsesn)
    status = viClose(defaultRM)
    TCP_IP_Test = 0
End Function
```

(3) Button control code:

```
Private Sub exitBtn_Click()  
    End  
End Sub  
Private Sub tcpipBtn_Click()  
    Dim stat As Long  
    stat = TCP_IP_Test(ipTxt.Text)  
    If (stat < VI_SUCCESS) Then  
        resultTxt.Text = Hex(stat)  
    End If  
End Sub  
Private Sub usbBtn_Click()  
    Dim stat As Long  
    stat = Usbtmc_test  
    If (stat < VI_SUCCESS) Then  
        resultTxt.Text = Hex(stat)  
    End If  
End Sub
```

The run result:

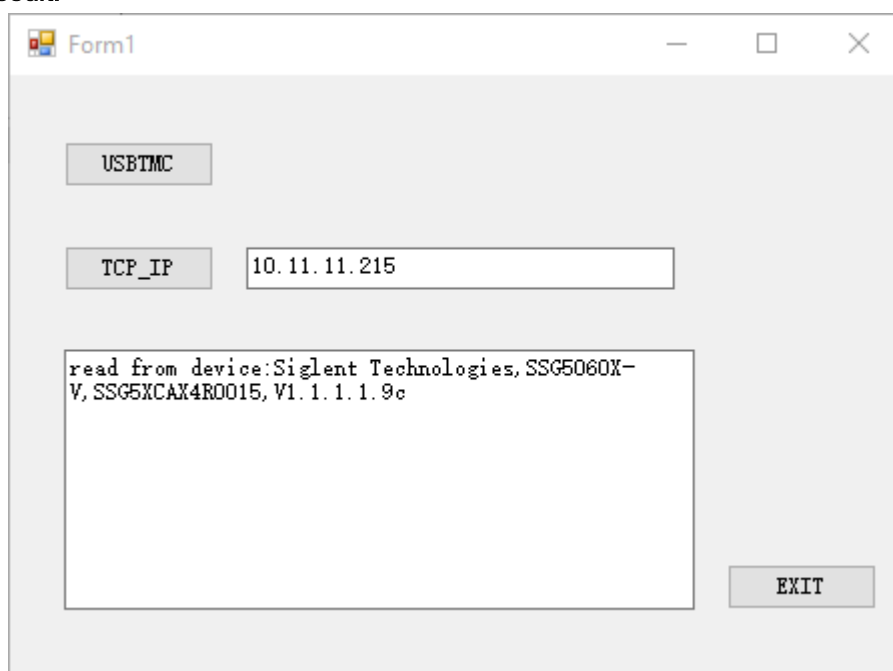

4.1.3 MATLAB Example

Environment: Win7 32bit system, MATLAB R2013a

The function of this example: Use National Instruments NI-VISA to control the device with USBTMC or TCP/IP access and perform write and read operations.

Follow the steps to complete the example:

1. Open MATLAB, modify the **current directory**. In this demo, the current directory is modified to D:\USBTMC_TCPIP_Demo.
2. Click **File>>New>>Script** in the Matlab interface to create an empty M file
3. Add codes:

(1) USBTMC access code

Write a function Usbtmc_test.

```
function Usbtmc_test()
% This code demonstrates sending synchronous read & write commands
% to an USB Test & Measurement Class (USBTMC) instrument using
% NI-VISA

%Create a VISA-USB object connected to a USB instrument
vu = visa('ni','USB0::0xF4EC::0x1501::0123456789::INSTR');

%Open the VISA object created
fopen(vu);

%Send the string "*IDN?",asking for the device's identification.
fprintf(vu, '*IDN?');

%Request the data
outputbuffer = fscanf(vu);
disp(outputbuffer);

%Close the VISA object
fclose(vu);
delete(vu);
clear vu;

end
```

The run result:

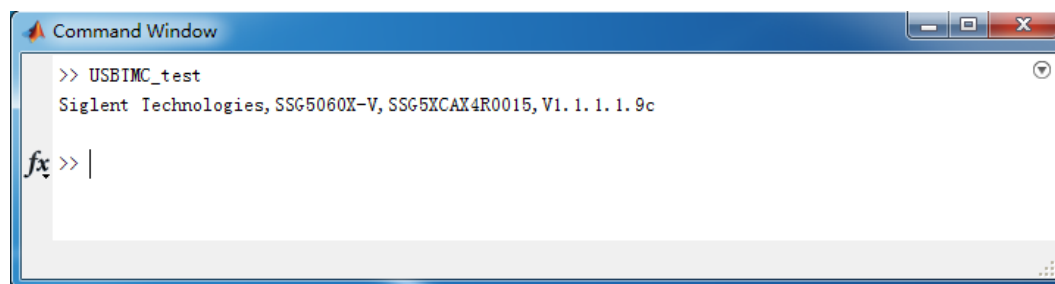

```
Command Window
>> USBIMC_test
Siglent Technologies, SSG5060X-V, SSG5XCAX4R0015, V1.1.1.1.9c
fx >> |
```

(2) TCP/IP access code.

Write a function TCP_IP_Test:

```
function TCP_IP_test()
% This code demonstrates sending synchronous read & write commands
% to an TCP/IP instrument using NI-VISA

%Create a VISA-TCPIP object connected to an instrument
%configured with IP address.
vt = visa('ni',['TCPIP0:','10.11.11.215', '::INSTR']);

%Open the VISA object created
fopen(vt);

%Send the string "*IDN?",asking for the device's identification.
fprintf(vt, '*IDN?');

%Request the data
outputbuffer = fscanf(vt);
disp(outputbuffer);

%Close the VISA object
fclose(vt);
delete(vt);
clear vt;

end
```

The run result:

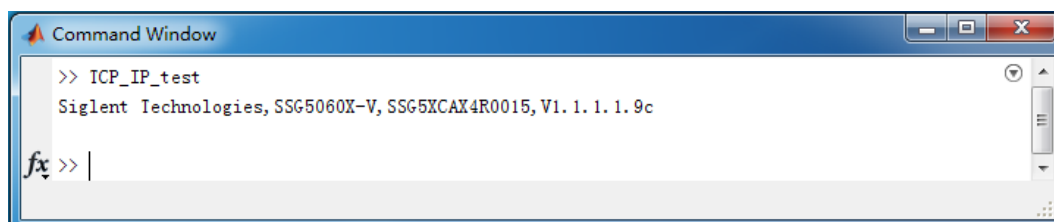

```
Command Window
>> ICP_IP_test
Siglent Technologies, SSG5060X-V, SSG5XCAX4R0015, V1.1.1.1.9c
fx >> |
```

4.1.4 LabVIEW Example

Environment: Win7 32bit system, LabVIEW 2011

The functions of this example: Use National Instruments NI-VISA to control the device with USBTMC and TCP/IP access to perform write and read operations.

Follow the steps to complete the example:

1. Open LabVIEW, create a VI file.
2. Add controls. Right-click in the **Front Panel** interface, select and add **VISA resource name**, error in, error out and some indicators from the Controls column.
3. Open the **Block Diagram** interface. Right-click on the **VISA resource name** and you can select and add the following functions from VISA Palette from the pop-up menu: **VISA Write**, **VISA Read**, **VISA Open** and **VISA Close**.
4. Connect them as shown in the figure below

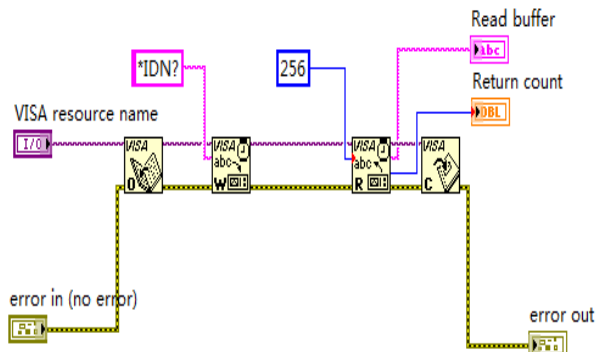

5. Select the device resource from the VISA Resource Name list box and run the program.

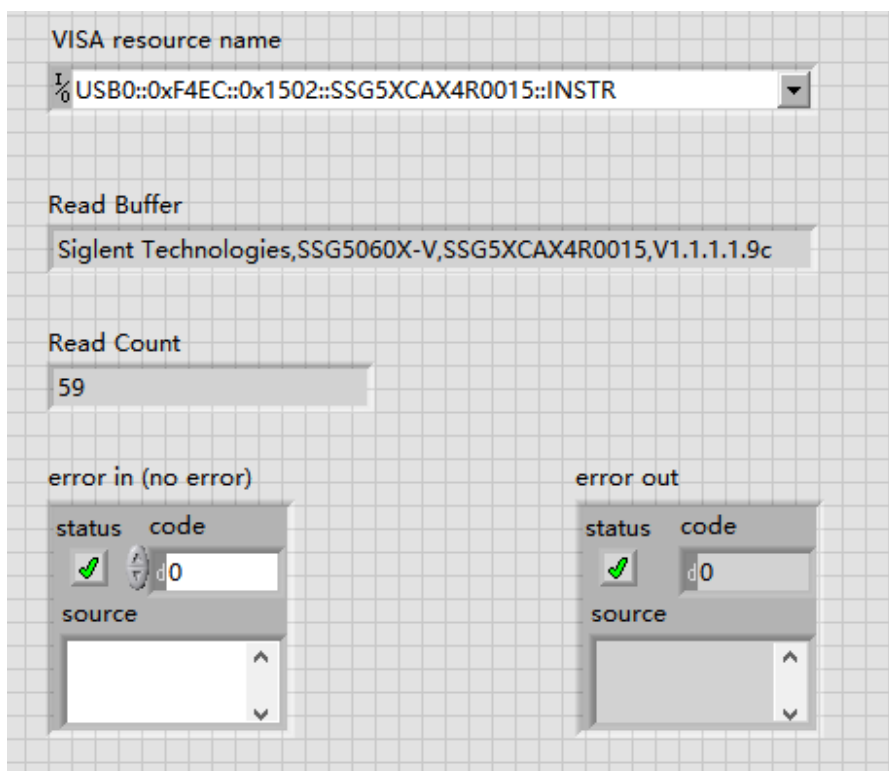

In this example, the VI opens a VISA session to a USBTMC device, writes a command to the device, and reads back the response. In this example, the specific command being sent is the device ID query. Check with your device manufacturer for the device command set. After all communication is complete, the VI closes the VISA session.

6. Communicating with the device via TCP/IP is similar to USBTMC. But you need to change VISA Write and VISA Read Function to Synchronous I/O. The LabVIEW default is asynchronous I/O. Right-click the node and select Synchronous I/O Mod>>Synchronous from the shortcut menu to write or read data synchronously.

7. Connect them as shown in the figure below

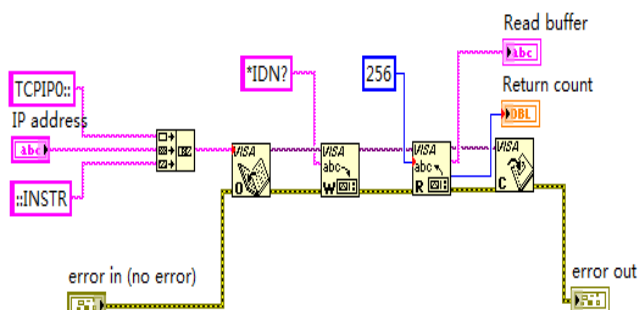

8. Input the IP address and run the program.

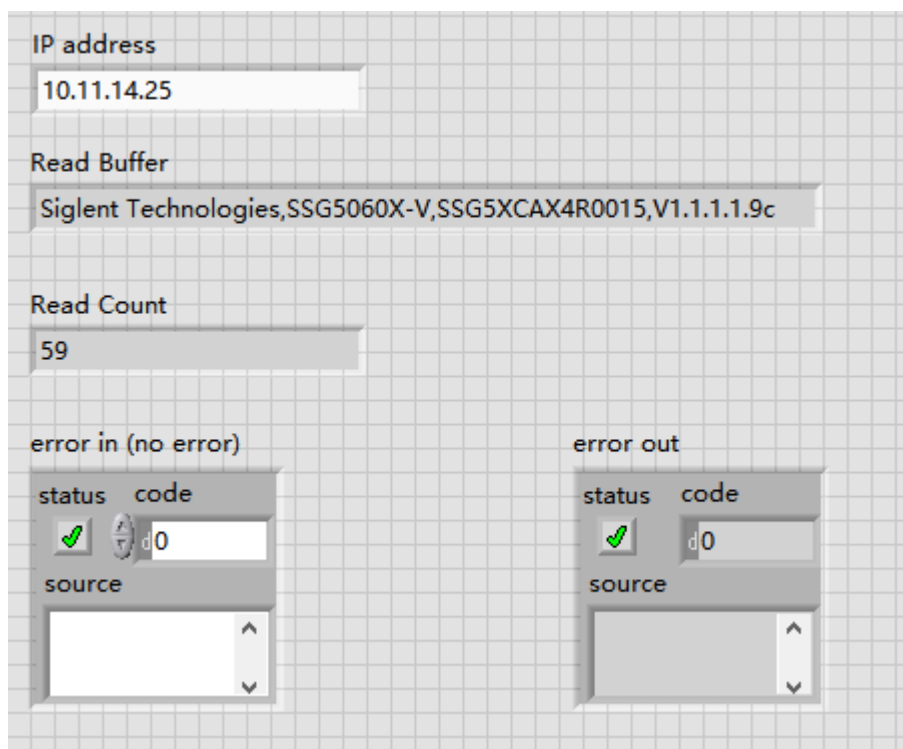

4.2 Socket Examples

4.2.1 Python Example

Python is an interpreted programming language that lets you work quickly and is very portable. Python has a low-level networking module that provides access to the socket interface. Python scripts can be written for sockets to do a variety of test and measurements tasks.

Environment: Win7 32bit system, Python v2.7.5

The functions of this example: Opens a socket, sends a query, and closes the socket. It does this loop 10 times.

Below is the code of the script:

```
#!/usr/bin/env python
#-*- coding:utf-8 -*-
#-----
# The short script is an example that open a socket, sends a query,
# print the return message and closes the socket.
#-----
import socket # for sockets
```

SIGLENT

```
import sys # for exit
import time # for sleep
#-----
remote_ip = "10.11.13.32" # should match the instrument's IP address
port = 5025 # the port number of the instrument service
count = 0

def SocketConnect():
    try:
        #create an AF_INET, STREAM socket (TCP)
        s = socket.socket(socket.AF_INET, socket.SOCK_STREAM)
    except socket.error:
        print ('Failed to create socket.')
        sys.exit();
    try:
        #Connect to remote server
        s.connect((remote_ip , port))
    except socket.error:
        print ('failed to connect to ip ' + remote_ip)
    return s

def SocketQuery(Sock, cmd):
    try :
        #Send cmd string
        Sock.sendall(cmd)
        time.sleep(1)
    except socket.error:
        #Send failed
        print ('Send failed')
        sys.exit()
    reply = Sock.recv(4096)
    return reply

def SocketClose(Sock):
    #close the socket
    Sock.close()
    time.sleep(.300)

def main():
    global remote_ip
    global port
    global count

    # Body: send the SCPI commands *IDN? 10 times and print the return message
```

```
s = SocketConnect()
for i in range(10):
    qStr = SocketQuery(s, b"*IDN?\n")
    print (str(count) + ":: " + str(qStr))
    count = count + 1
SocketClose(s)
input('Press "Enter" to exit')

if __name__ == '__main__':
    proc = main()
```

The run result:

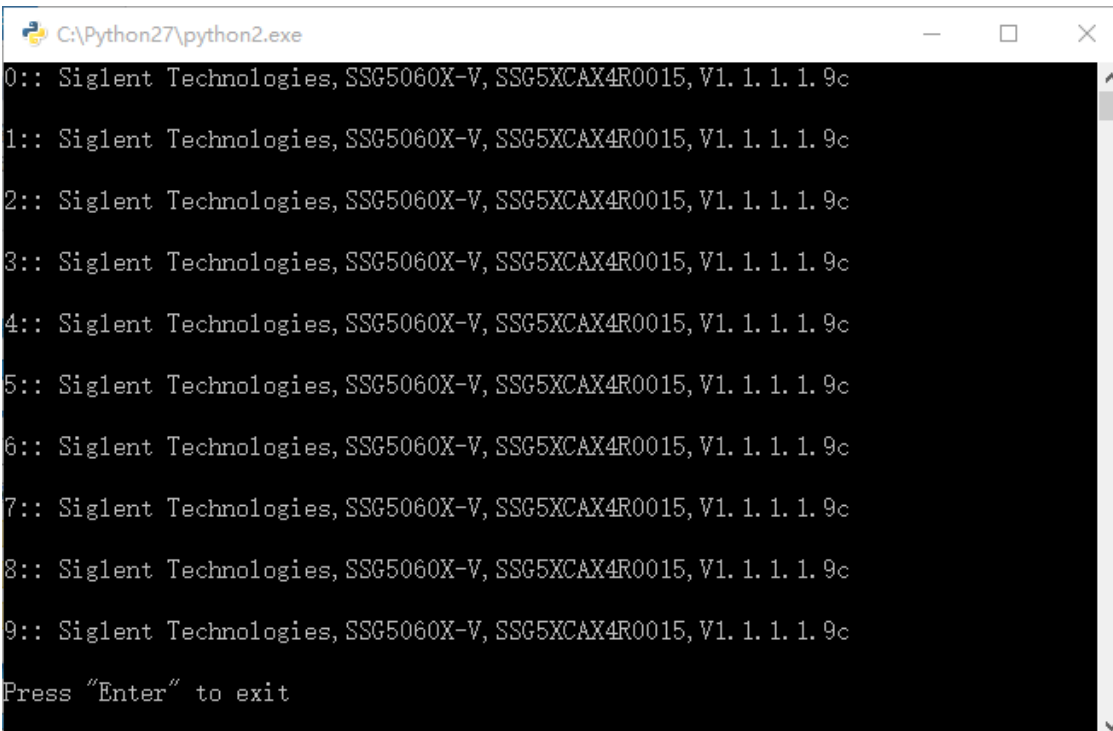

```
C:\Python27\python2.exe
0:: Siglent Technologies, SSG5060X-V, SSG5XCAX4R0015, V1. 1. 1. 1. 9c
1:: Siglent Technologies, SSG5060X-V, SSG5XCAX4R0015, V1. 1. 1. 1. 9c
2:: Siglent Technologies, SSG5060X-V, SSG5XCAX4R0015, V1. 1. 1. 1. 9c
3:: Siglent Technologies, SSG5060X-V, SSG5XCAX4R0015, V1. 1. 1. 1. 9c
4:: Siglent Technologies, SSG5060X-V, SSG5XCAX4R0015, V1. 1. 1. 1. 9c
5:: Siglent Technologies, SSG5060X-V, SSG5XCAX4R0015, V1. 1. 1. 1. 9c
6:: Siglent Technologies, SSG5060X-V, SSG5XCAX4R0015, V1. 1. 1. 1. 9c
7:: Siglent Technologies, SSG5060X-V, SSG5XCAX4R0015, V1. 1. 1. 1. 9c
8:: Siglent Technologies, SSG5060X-V, SSG5XCAX4R0015, V1. 1. 1. 1. 9c
9:: Siglent Technologies, SSG5060X-V, SSG5XCAX4R0015, V1. 1. 1. 1. 9c
Press "Enter" to exit
```

4.2.2 Telnet Example

Telnet SCPI: Provides the ability to send single SCPI commands from a remote PC to the signal generator using LAN port number 5024.

How to send single SCPI commands using Telnet:

1. On the remote PC, click Start, then Run
2. Type: **telnet <ip address> 5024**
3. A Telnet window with a **>>>** prompt should appear on the remote PC screen.



```
Telnet 10.11.14.94
Welcome to the SCPI instrument 'Siglent SSG5060X-V'
>>
```

4. From the SCPI prompt:

- Type single SCPI commands. Press Enter to send the command.

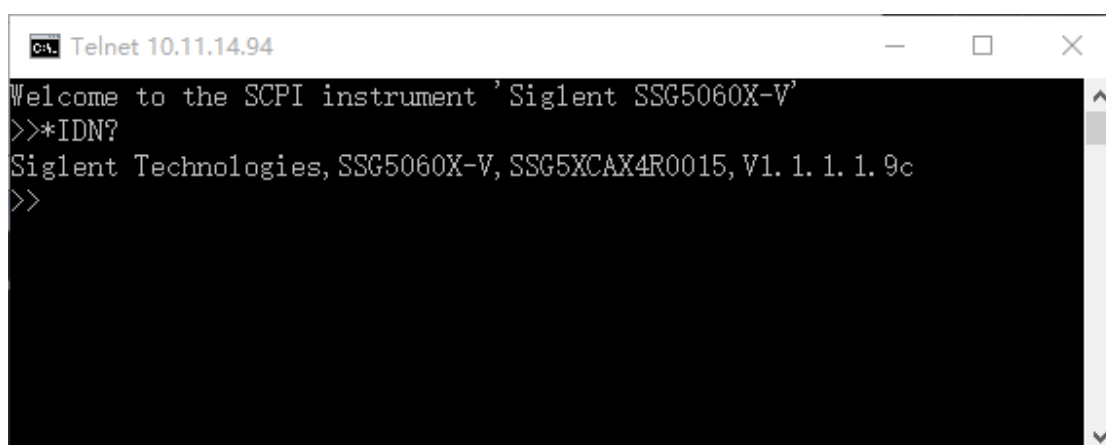

```
Telnet 10.11.14.94
Welcome to the SCPI instrument 'Siglent SSG5060X-V'
>>*IDN?
Siglent Technologies, SSG5060X-V, SSG5XCAX4R0015, V1. 1. 1. 1. 9c
>>
```

- To exit the telnet window click X in the upper-right corner.
- To get a normal telnet prompt, press Ctrl +] (closing bracket).

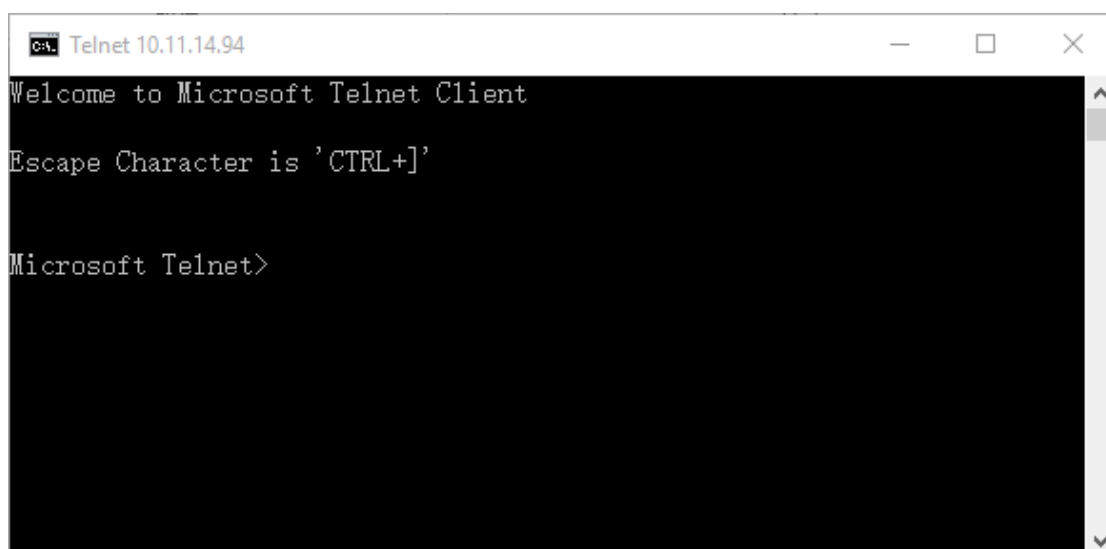

```
Telnet 10.11.14.94
Welcome to Microsoft Telnet Client
Escape Character is 'CTRL+]'
Microsoft Telnet>
```

- To get SCPI prompt again, type open <ip Address> 5024 and press Enter:

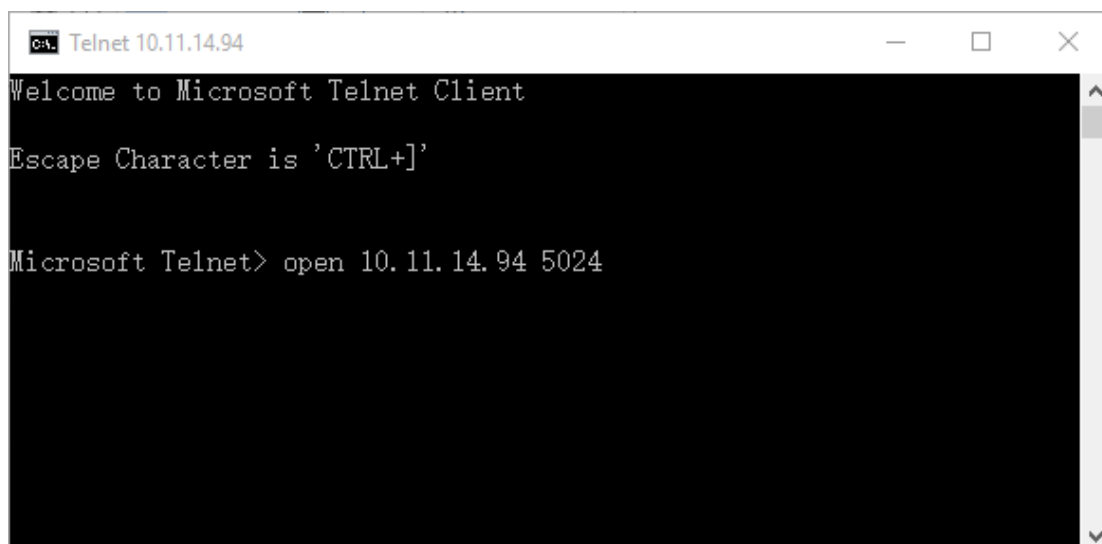

A screenshot of a Microsoft Telnet Client window titled "Telnet 10.11.14.94". The window has a black background with white text. The text displayed is: "Welcome to Microsoft Telnet Client", "Escape Character is 'CTRL+]", and "Microsoft Telnet> open 10.11.14.94 5024". The window has standard Windows window controls (minimize, maximize, close) in the top right corner.

- To close the normal telnet window, type **Quit** and press **Enter**.

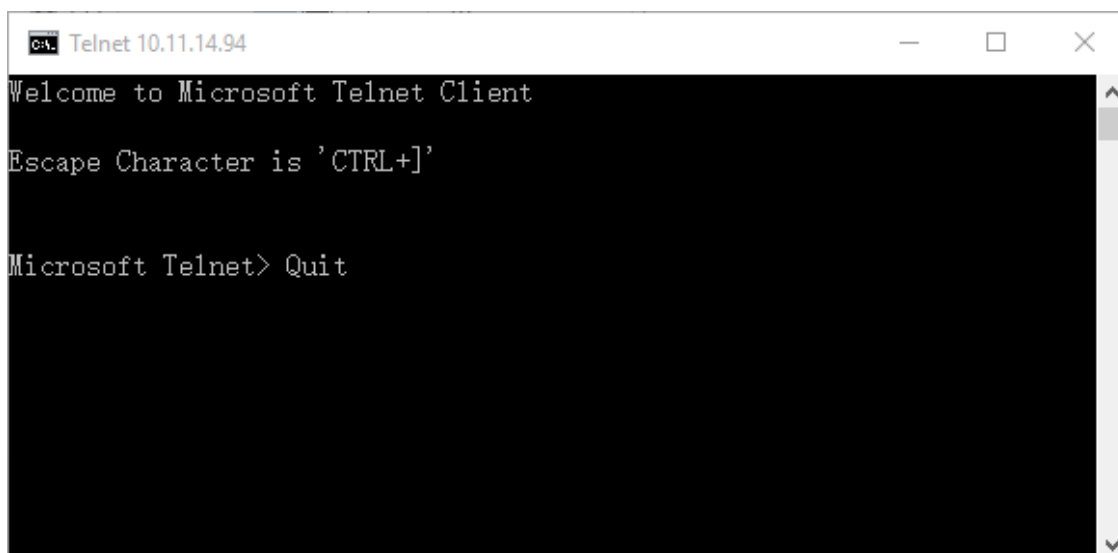

A screenshot of a Microsoft Telnet Client window titled "Telnet 10.11.14.94". The window has a black background with white text. The text displayed is: "Welcome to Microsoft Telnet Client", "Escape Character is 'CTRL+]", and "Microsoft Telnet> Quit". The window has standard Windows window controls (minimize, maximize, close) in the top right corner.